

BROSELEY

Installation & Operating Instructions

Model: Gas Q7 MK2

**Variants Covered: Ignite 7 (CD1), Hereford 7 (CD2)
& Desire 7 (SD1)**

Conventional Flue Natural Gas Stove

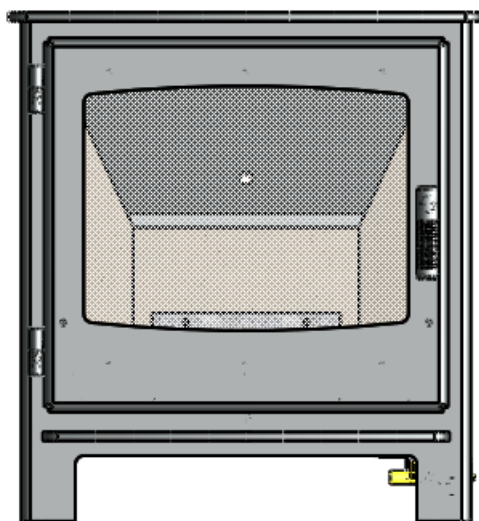

Top Flue Outlet Only

IT IS A REGULATION THAT THESE INSTRUCTIONS ARE HANDED TO THE CUSTOMER AFTER THE INSTALLATION IS COMPLETE. IT IS ALSO THE RESPONSIBILITY OF THE INSTALLATION ENGINEER TO ENSURE THE CUSTOMER IS ABLE TO FULLY OPERATE THE APPLIANCE AND IS AWARE OF ANY CLEANING OR MAINTENANCE REQUIREMENTS.

Please note: Gas installations MUST only be carried out by installers who are Gas Safe registered.

Warning - Appliance should not be used if the glass in the door is cracked, damaged or broken.

This product is not suitable for primary heating purposes.

Chimney closure plates are not supplied

Contents

Introduction	3
Packing List	3
Specification	4
Dimensions	4
Hearth Requirements	5
Chimney Requirements	6
Assembly	
Burner Installation	7
Mica Board Installation	9
Fitting the Decorative Log Retainer	10
Connecting the TTB Sensor	10
Positioning the logs	11
Assembling the door handle	20
Gas Connection & Pressure Testing	20
Spillage Testing	21
Maintenance	22
Operating the Stove	23
Cleaning the Stove	24
Curing the Paint	24
Trouble-shooting and Servicing	25
Commissioning Form	27
Guarantee	28
Energy Efficiency Rating	29

Introduction

THANK YOU FOR PURCHASING A BROSELEY GAS STOVE

Broseley Fires Ltd, a family run company, was founded as an appliance and design development company in 1975.

Since then we have built up an enviable reputation for the quality, reliability and fuel efficiency of our stoves.

These instructions have been carefully prepared to guide the installer and end-user through the relevant methods and standards for installation of your new Gas Stove.

Correctly installed and operated, your stove will give you many years of warmth and reliability. Therefore, we would suggest that you read the whole instruction manual prior to handing it to your installer. That way you will have a clearer picture of what is involved.

It is required by law that the complete assembly, installation and commissioning of gas stoves is carried out by a professionally qualified and accredited gas fitter listed on the “**Gas Safe**” register.

THE INSTALLATION MUST BE IN ACCORDANCE WITH THE ‘GAS SAFETY INSTALLATION AND USE REGULATIONS’ IN CONJUNCTION WITH THESE INSTRUCTIONS AND THE RELEVANT ‘BRITISH STANDARDS CODES OF PRACTICE’ REQUIREMENTS AND THE RELEVANT ‘LOCAL AND NATIONAL BUILDING REGULATIONS’. A COMMISSIONING CERTIFICATE MUST BE LEFT WITH THE END CUSTOMER UPON FINAL COMPLETION AND THE COMMISSIONING FORM COMPLETED IN THE BACK OF THESE INSTRUCTIONS.

Packing List

Stove Box

1 x Stove (with burner and mica boards fitted)
1 x Flue spigot
3 x Spigot fixings
1 x Instruction manual

Fibre Box

1 x Main Base Ceramic
10 x Loose logs

Specification

Heat Input (Gross)	6.5kW
Gas Category	I _{2H}
Supply Pressure	20 mbar
Gas Rate	0.602 m ³ /hr
Injector Size	Q7
Flue diameter	125mm (5")
Country of destination	GB, IE
Efficiency Class	Class 1
Nominal Output	4.7kW
NOx	130 mg/kWh (GCV)

Please note this product is designed to only use natural gas G20.

Dimensions

Ignite CD1 Q7 - WEIGHT 75 Kg
Hereford CD2 Q7 – WEIGHT 68 Kg
Desire SD1 Q7 – WEIGHT 71 Kg

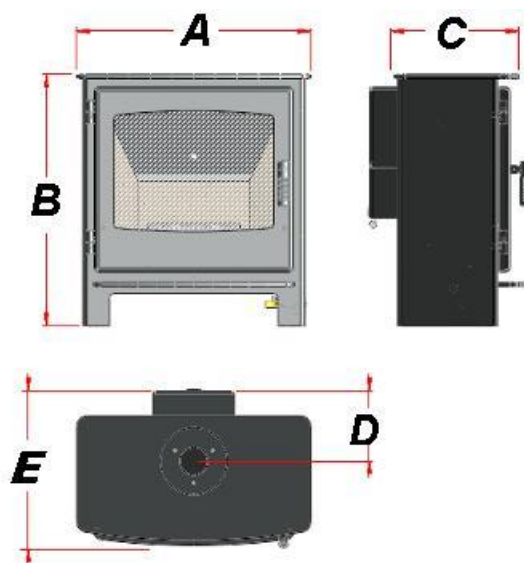

All dimensions are in millimetres.

	Ignite CD1	Hereford CD2	Desire SD1
A	542	565	542
B	582	608	582
C	288	285	288
D	162	165	162
E	345	342	345

The front, sides and top are considered working surfaces of the appliance.

Hearth Requirements

The appliance needs to be located onto a solid non-combustible hearth with a minimum thickness of 12mm. The hearth must be capable of withstanding the weight of the appliance.

NB Measurements taken from the Lid of the stove (Dimension C on page 4):

Ensure all minimum clearances to combustible materials are complied with as below:

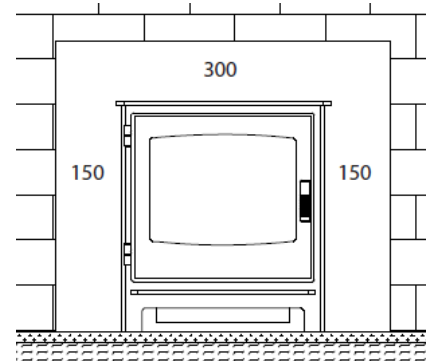
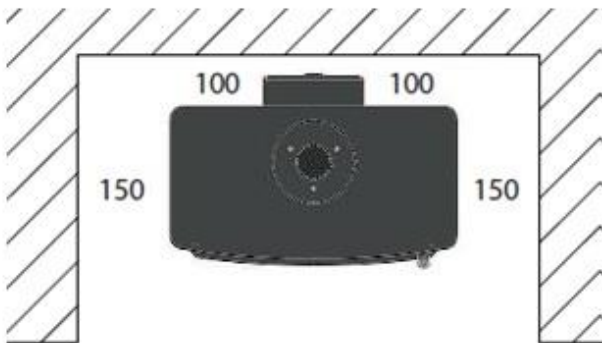

Hearth Protrusion (in front of the appliance)	50mm
Shelf Distance (above the stove)	300mm

The specified minimum clearances provide the minimum distance to combustible and non-combustible materials. If the appliance is intended to be installed into a non-combustible opening, the clearances to the sides and above can be reduced. However it is recommended that the specific minimum clearances are maintained, irrespective of the materials used in the construction of the opening. This has been tested and approved, to allow adequate air flow and access to the controls, as well as allowing access for smoke tests and future maintenance of the flue and the appliance.

The clearance to the rear of the appliance must always be a minimum of 100mm. Clearances to combustible materials cannot be reduced

Please note the gas supply connection to the appliance is to the right hand side rear of the stove. The connection requires an 8mm-diameter semi-rigid pipe, not more than 1 meter in length.

Additional Requirements

- Curtains should not be positioned above the appliance at a distance of less than the minimum specified for shelves
- An additional guard is to be used to take account of the special hazards that exist in nurseries and other places where there are young children or aged or infirm persons present.

Chimney Requirements

Please note Broseley Fires do not provide flue pipes, closure plates or any other associated accessory.

Top Flue Outlet Only

The stove must be installed in accordance with current gas and buildings regulations BS5871: Part1. The appliance can be installed in any adequate area suitable for solid fuel fires and stoves. It can use a class 1, class 2 and pre-cast flue.

For pre-cast flue installations it is ESSENTIAL that a sealed connection is made into the actual flue system (a void behind a closure plate is not permitted). Please refer to the codes of best practice for further advice on pre-cast flues. Before you install the stove, make sure the chimney flue outlet is correctly positioned to align with the flue outlet on the stove and that the chimney is in good condition. If not, a chimney liner must be installed or a suitable class II gas flue used. A draught is necessary to ensure the products of combustion are fully evacuated.

Ideally it is recommended that the flue run is as straight as possible. The flue must have a minimum vertical height of 3 metres to insure adequate draught. You can have a maximum of four bends in the run, each bend must not exceed 45° and an additional metre of vertical flue should be provided for each bend. Ideally you should have a minimum vertical section of 600mm before any bend immediately off the top of the appliance, however it is permitted to use a 45° bend straight off the appliance provided you have an adequate flue draft.

Prior to installation, the installer should insure that the flue is free from obstruction and any dampers must be fixed in a permanently open position. Ensure the chimney is not closed and that it has been swept and subsequently smoke tested.

Make sure that rain, birds or any foreign body cannot get into the chimney to cause damage or blockage. This problem can normally be overcome by fitting an approved gas cowl. It is essential for the effective running of your stove that the chimney draws properly to allow the products of combustion to escape.

VENTILATION (GB ONLY)

The gas stove is rated at less than 7kw and therefore does not normally require additional ventilation in the room (BS5871 – part II).

Flue Spigot Connection

Attach the supplied spigot to the top of the stove using the three M6x40 bolts and washers provided.

Assembly - Burner Installation

The burner will come pre-fitted, however please ensure all components are present and fitted as per the information below to ensure nothing has moved (or become damaged) in transit. You will need a pozi drive screwdriver when fitting/replacing the gas burner.

- 1) Remove the stove body from its packaging and stand it in position.
- 2) Open the main door.
- 3) Insert the burner end with the control knob first followed by the other end of the burner locating the burner bracket onto the side fixing points.
- 4) Fasten the burner into position using two (2) M6x40 bolts and washers provided.

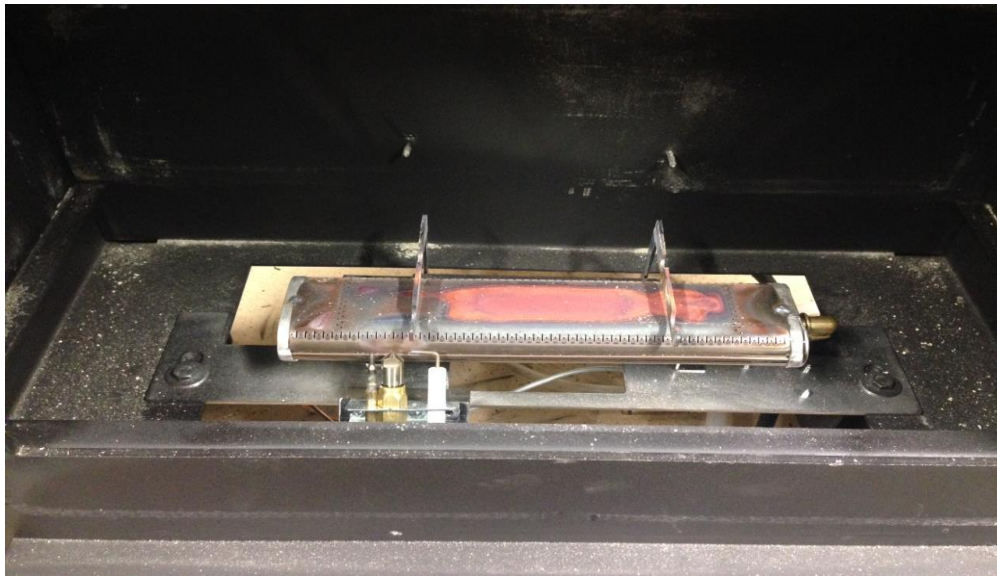

- 5) The stove base plate can now be fitted. This plate rests on the base on the stove

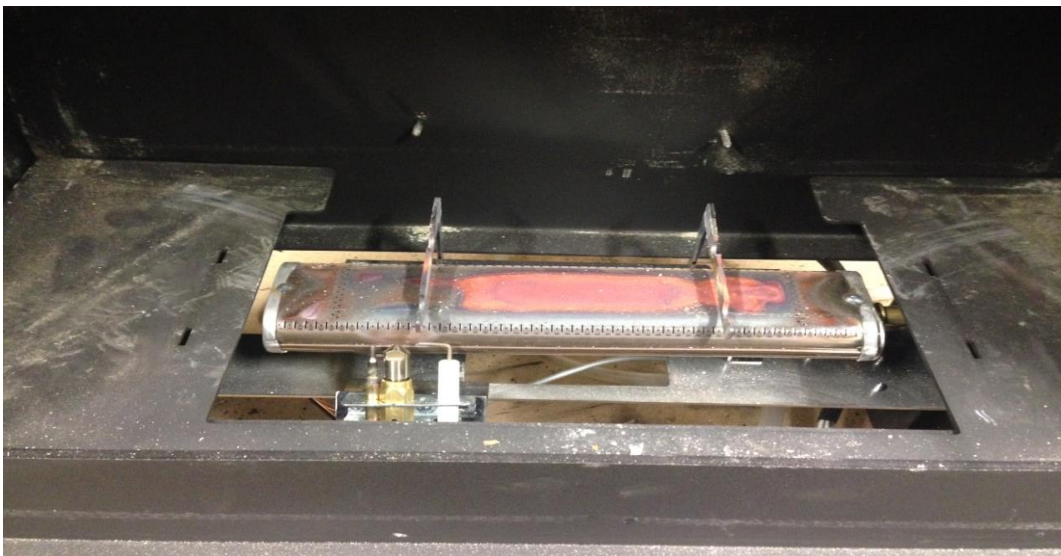

Assembly - Burner Installation

- 6) Next place the 2 x ceramic rods into the slots located in the bracket above the burner as pictured.

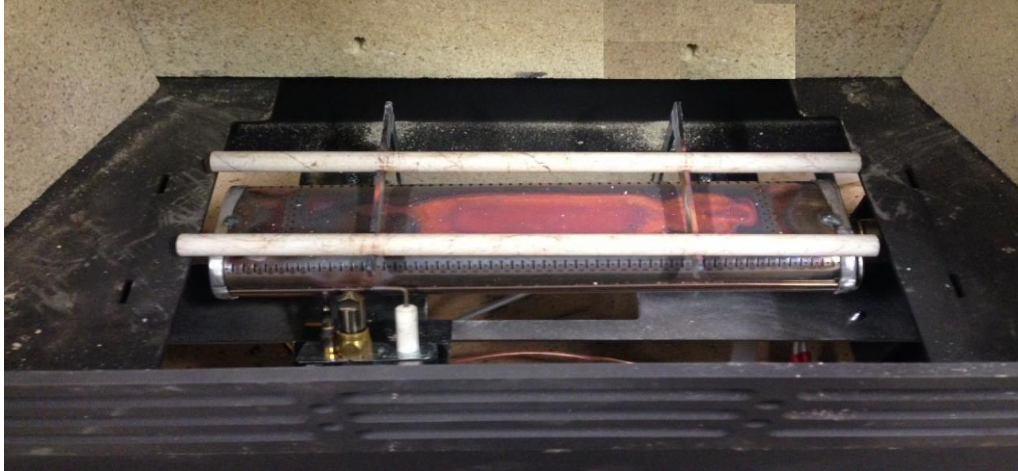

- 7) Next fit the mica boards as detailed in the next section. Page 9

Assembly – Mica Boards

As with the burner, the Mica boards will be pre-fitted into the stove. The information below will assist with the removal/re-installation should they need to be removed for maintenance purposes.

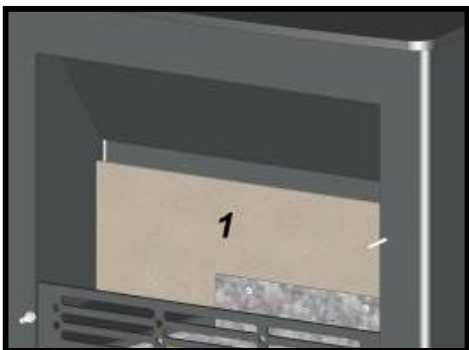

First fit the rear mica board as shown above.

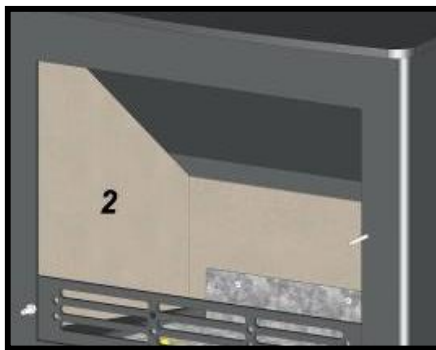

Now fit one of the side mica boards ensuring that the board is snug between the front of the stove and the rear mica

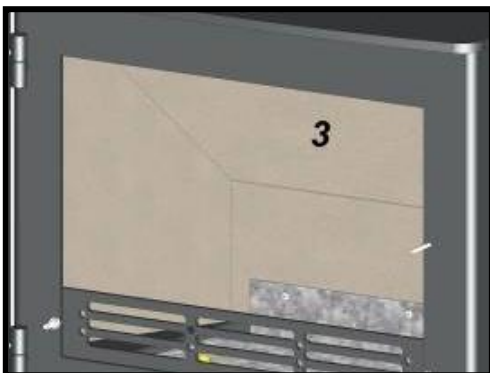

Next rest the top mica board onto the side board (this board will need supporting whilst the final side board is fitted).



Finally fit the reaming side mica board and allow the top board to rest down onto it (the top board should now be supported by both the side and rear mica boards). The side boards sit on an inwards angle towards the rear of stove.

Please note you may also need to remove the pilot shield (plastic cover) from the pilot before fitting the ceramics (this protects the pilot during transit).

Assembly – Decorative Log Retainer

Using the 2 off M5 C/Sunk Bolts provided, locate the decorative trim behind the stove opening as shown and secure in position.

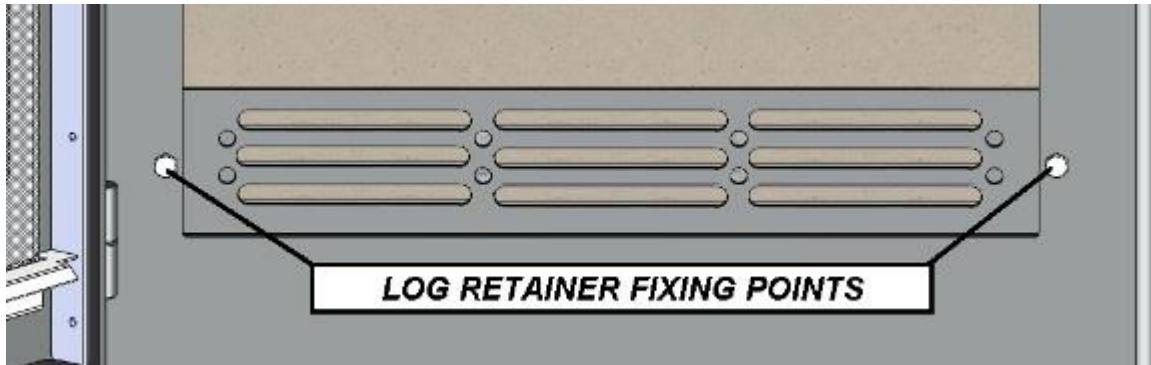

Assembly - Fitting TTB sensor

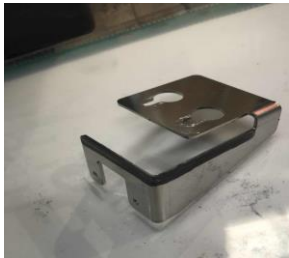

With the burner installed, thread the 2 x TTB wires from the pilot / thermocouple to the rear of the stove. Attach the two spade connections to the TTB which is fitted to the bracket shown in Fig 1. Attach the bracket to rear panel of the stove by inserting the keyhole cut-outs over the existing screw heads and drop down to final position. Tighten screws if required. Ensure the white fibre is between the stove and bracket.

Fig 1

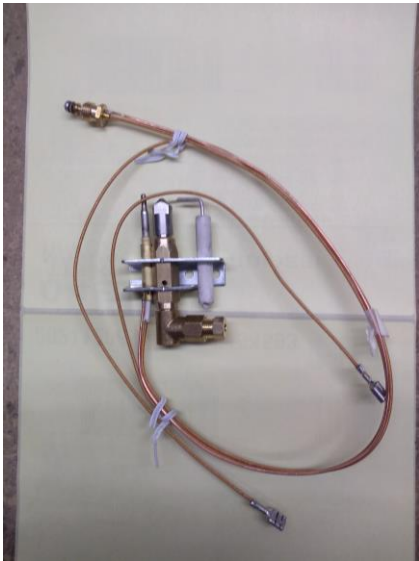

Pilot Assembly



Connection to gas valve



TTB Connections

Assembly - Positioning the Logs

Only the ceramics supplied with this appliance should be used. The ceramics should only be laid as described. Before any ceramics are placed in position ensure that the pilot is not obstructed and the burner is operating correctly. Broseley Fires Ltd accepts no responsibility for any injury sustained whilst handling hot ceramics. Ceramics which are found to be placed other than in accordance with these instructions will result in a charge being made following any service callout. Replacement ceramics are available from your dealer.

We recommend lighting the burner for several minutes prior to positioning the ceramics. Once layout is complete, fire the burner and look for soot deposits. If soot is evident slight adjustments may need to be made to logs.

1: Place main base ceramic on top of the burner ensuring that it is located centrally left and right. The circle cut out at the front of the main fuel bed should be central to the pilot.

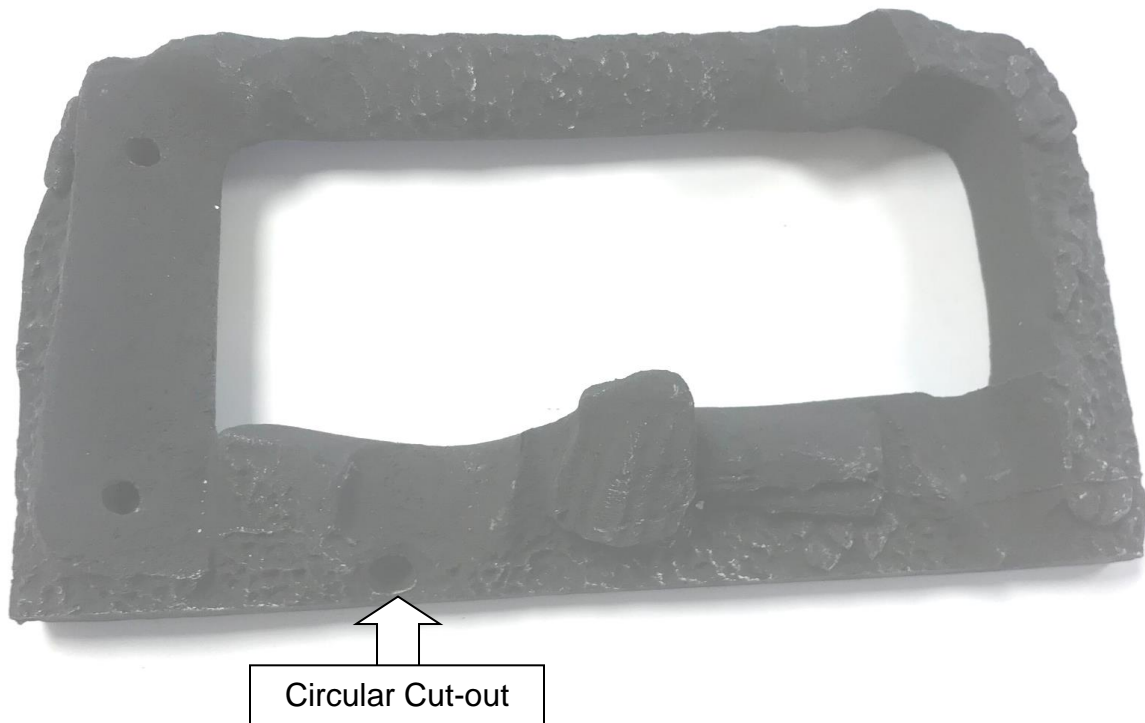

Assembly - Positioning the Logs

2: Position the left as shown using the two pegging points, please note you should have a single peg pointing upwards at the back.



3: Do the same for the right hand side, again you should have a single peg pointing upwards at the back. Please note this lug simply rests into the recesses in the base rather than being pegged.

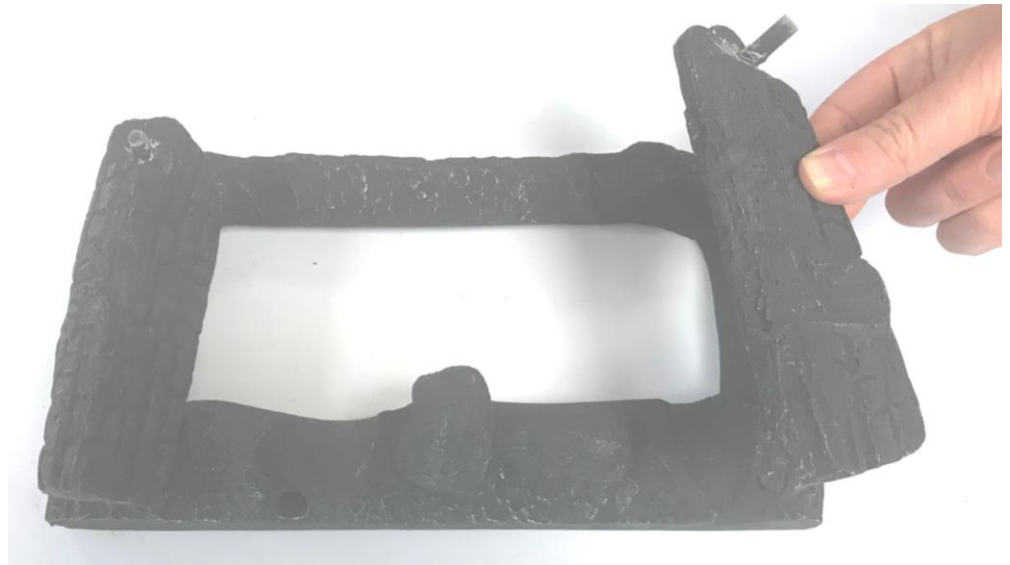

After steps 1-3 your log layout should look like this.



Assembly - Positioning the Logs

4: Interlock the rear log into position as shown below



Position the rear log as shown with the thinner end to the right and the three holes facing you. This log locates onto the pegs at the back (as established in steps 2 and 3).



After step 4 your log layout should look like this.

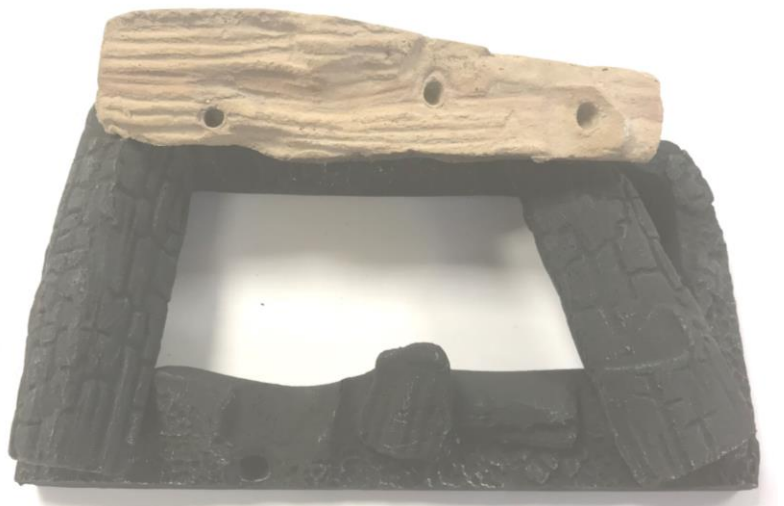

Assembly - Positioning the Logs

5: Position the central log as shown. This log has a peg which locates into the central hole in the rear log.



After step 5 your log layout should look like this.



Assembly - Positioning the Logs

6: Position the next log as shown so that it locates onto the peg of the central log.



After step 6 your log layout should look like this.



Assembly - Positioning the Logs

7: The next ceramic locates into the right hole in the rear ceramic as shown.



After step 7 your log layout should look like this.



Assembly - Positioning the Logs

8: This ceramic locates into the left most hole in the rear ceramic.

You should have a peg pointing up at the front now.



After step 8 your log layout should look like this.



Assembly - Positioning the Logs

9: Position the small front log onto the last remaining peg as shown.



After step 9
your log layout
should look like
this.



Assembly - Positioning the Logs

10: Finally position the far left and far right logs as shown in the final ceramic layout below. These logs do not have location points and simply rest up against the side vermiculite as pictured.

The final ceramic layout should look like this.



Assembly – Assembling the door handle

Push the stove door closed and secure it by attaching the handle and turning it clockwise until you achieve a gas tight seal.



Assembly - Gas Connection & Pressure Testing

A minimum 15mm-diameter gas supply pipe must be used to within 1 metre of the installation with the final connection to the stove to be completed with the suitable 8mm semi-rigid gas pipe. The 8mm pipe should be connected to the inlet of the gas valve using the nut and 8mm olive provided. Support the control whilst finally tightening the supply pipe.

The gas supply connection to the appliance is located at the right hand side rear of the stove. The connection requires an 8mm-diameter semi-rigid pipe, not more than 1 meter in length. This connection is a compression fitting, sealant should never be used (as this can potentially cause a blockage).

Pressure Testing

Always make sure that there is adequate gas pressure and volume to the stove. The relevant pressures are on the ID plate on the gas control knob.

1. **For natural gas, this is 20mbar** measured at the inlet connection to the stove with the appliance in the full rate position.
2. Ensure that the gas pressure to the stove is maintained when it is operating at the same time as other appliances in the building and that a suitable pressure gauge is used i.e. a manometer. **Any service call as a result of incorrect gas pressure will be chargeable.**

Ventilation (GB only)

The gas stove is rated at less than 7kw and therefore does not normally require additional ventilation in the room (BS5871 – part II).

Spillage Testing

A Spillage Test **MUST** be made before the installed fire is left with the customer.

Carry out the test by first closing all doors and windows in the room containing the fire. Ensure that the fire is burning at full rate for a minimum of 10-15 minutes.

Using a lighted smoke match, run it along under the rear edge of the stove. The draught diverter box is situated at the rear of the stove, the entry being in the rear panel for the stove. Observe the smoke being drawn into the dilution box. After 10 minutes repeat the test

If there is an extractor fan in a nearby room the spillage test must be repeated with the fan running and all connecting doors between the fire and fan left open.

If there are still problems, the chimney / flue may require attention. Disconnect the stove and seek expert advice.

Spillage Monitoring System

This appliance is fitted with an atmospheric sensing spillage monitoring system, in the form of an oxygen depletion-sensing pilot. This is designed to shut down the fire within a safe period if there is an excessive build up of products of combustion within the room space. This would usually only occur if the flue path suffered severe blockage and / or ventilation was severely impeded.

THE FOLLOWING ARE IMPORTANT WARNINGS RELATIVE TO THE SPILLAGE MONITORING SYSTEM

1. The installer must not attempt any adjustments to the spillage monitoring system.
2. There must be no attempt to disable the spillage monitoring system.
3. It is not possible to replace individual parts of the pilot assembly on the appliance – only a complete pilot assembly (including thermocouple) may be fitted in the event of a replacement being necessary. When the spillage monitoring system is replaced, only complete and original manufactures' parts may be fitted.
4. Should the appliance turn itself off, wait for a minimum of 3 minutes before attempting to re-light. In the event of your stove tripping out, consult your installation engineer to have the flue / chimney checked.

Maintenance

Door adjustment

In the case of the door rope not providing an adequate seal to the room, products of combustion may enter the room (see warning notes), to ensure an adequate seal the door may need to be periodically adjusted as the rope seal wears with use.

Hinge Adjustment (seal on Left hand side is not compressed): SD1 AND CD1 MODELS ONLY

- Ensure that the stove is cold before proceeding
- Remove the door by lifting the door off the hinges
- Loosen the Hinge Locking nut inside the stove
- Rotate the hinge by 1 turn (clockwise to tighten seal, anticlockwise to loosen seal) on both the top and bottom hinge, this ensures that the door seal will compress or loosen evenly
- Re fit the door back onto the hinges and tighten the locking nut inside the stove
- Check the seal provides an adequate seal.



Operating the Stove

It is important to read these instructions thoroughly before lighting the stove.

The gas stove operates with a traditional permanent pilot light.

The knob for ignition and power control is located on the lower right hand side of the stove, the indicator in the plate shows the knob position (Marked on knob)

The pilot light is located at the front left corner of the coal matrix.

If the Flame Supervision Device Actuating Flame (the pilot light) is extinguished by intention or not, no attempt should be made to re-light **until 3 minutes have elapsed.**

IGNITING THE PILOT AND USING THE HIGH/LOW FUNCTION

1. Depress the control knob fully.
2. Whilst depressed, turn knob sharply 90 degrees anti-clockwise to "pilot" setting. Repeat until pilot light is visibly lit. You should feel some resistance and hear a click. Repeat until the pilot lights.
3. **Keep knob depressed at this point for 15-20 seconds.**
4. Upon releasing, turn the knob Anti-clockwise to select the low flame setting. Turning the control further anti-clockwise you will be able to select the high flame setting.
5. From the high setting you can select low by turning the control knob clockwise

EXTINGUISHING THE STOVE FULLY

1. From any heat setting or the permanent pilot, depress control knob and turn clockwise to "OFF" position.

Important Note:

Should the glass door become broken or damaged in any way, turn your stove off and do not attempt to re-light it. Contact your dealer for a replacement to be fitted before relighting the appliance.

The glass used in this appliance is a ceramic type glass suitable for operation up to 750 Degrees, do not use any other types of glass in this appliance.

PLEASE EXPLAIN TO THE CUSTOMER THESE LIGHTING AND EXTINGUISHING PROCEDURES AND THAT IT IS NORMAL FOR THE STOVE TO GIVE OFF ODOURS WHILST THE PAINT, SEALANT AND CAST IRON MATURES.

Cleaning the stove

We recommend only doing this when the stove is cold using a soft brush to clean any of the stove surfaces, this is normally sufficient to remove dust, ash and debris. For stubborn marks you can use a damp lint free cloth, ensure that all surfaces are dried off immediately. We do not recommend using any kind of chemicals or abrasive materials. It is possible to touch up the paint using the original metallic black stove paint, however this new paint will then need to cure.

Curing the Paint

It is important to note that upon initial lighting of the stove you will notice a strong odour, this is the paint curing and is completely normal.

Most high temperature paints operate in the same way. They use a resin which dries at room temperature and a silicon resin which cures at high temperatures. When the stove is burned the dry resin burns away and the silicon cures. This transition occurs about 240 degrees C / 475 degrees F.

After the stove burns about three times, the entire surface which gets hot will have cured. The house needs to be fully ventilated during these initial burnings and although the smoke is mostly Carbon Dioxide there are other components of the smoke which make it smell bad and may irritate some people. These problems will go away after the first few burns depending of the duration and surface temperature of each burn. The hotter the stoves gets the more it will cure.

This product is free from asbestos.

This product uses components containing Refractory Ceramic Fibre (RCF), which are man-made vitreous silicate fibres. Excessive exposure to these materials may cause temporary irritation to eyes, skin and respiratory tract, consequently, it makes sense to take care when handling these articles to ensure that the release of dust is kept to a minimum. To ensure that the release of fibres from these RCF articles is kept to a minimum, during installation and servicing we recommend that you use a HEPA filtered vacuum to remove any dust and soot accumulated in and around the fire before and after working on the fire. When replacing these articles we recommend that the replaced items are not broken up, but are sealed within a heavy polythene bag, and clearly marked as RCF waste. RCF waste is classed as a stable, non-reactive hazardous waste and may be disposed at a landfill licensed to accept such waste. Protective clothing is not required when handling these articles, but we do recommend you follow the normal hygiene rules of not smoking, eating or drinking in the work area and always wash your hands before eating or drinking.

Trouble-shooting

The gas pilot will not ignite or stay lit

- Ensure the gas is turned on at the appliance and the meter / cylinder.
- Check for blockages (especially after the pressure test point connection).
- Is there a strong spark being generated, If not firstly check that the spade connection is push fully into the pilot assembly. If still issues check that the spark generator has not been bent in transit – if it has, bend the metal generator so the spark is hitting above the pilots gas outlet not below. The spark generator should be ideally 10mm from the pilot head
- The pilot gas button must be held in for at least 20 seconds once the pilot is established to ensure the safety thermocouple is heated sufficiently.
- Ensure that both ends of the TTB connection cable are firmly connected and not damaged. If no damage, look at tightening the thermocouple connection to the splitter (see page 10). You will need an 8mm spanner.
- Make sure that the brass interrupter (connects thermos-couple and TTB to valve – shown on page 9) is not loose. You should not be able to move the interrupter by hand. Any break in the following circuit will cause the pilot not to stay alight as the electrical charge from the thermos-couple needs to arrive at the valve to keep it lit:

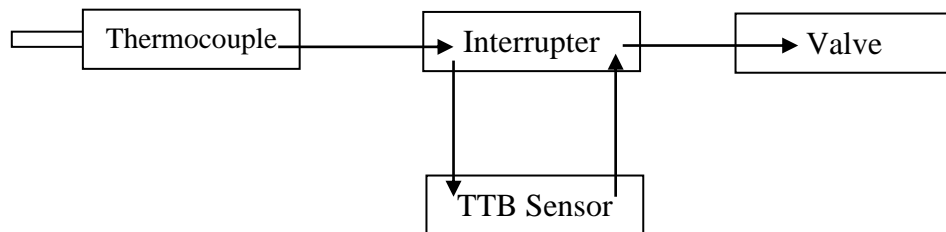

- Take care not to overtighten the interrupter unit into the valve as this can twist the spade connections. As you look at the back of the interrupter the spade connections should look like two vertical lines (if they are more like 45° then it's too tight)



- Ensure that the pilot head, injector and burner ports are not obstructed or blocked and are free from any dust or dirt.
- Ensure gas pressures and flow rates are correct, as this will prevent ignition of the pilot. An indication of high pressure can be a whistling sound from the pilot.
- Ensure that the pilot assembly has not been damaged in transit. Be sure to check the gap between the thermocouple and electrode is sufficient and that the spark is not arcing elsewhere, this is a very delicate device.
- The pilot flame should burn with a strong blue flame. The flame should be focused on the tip of the thermocouple.

Trouble-shooting

The main burner does not seem to burn correctly or will not stay alight

- Check the flue draft. In adverse conditions and when the flue is extremely cold it is possible the products of combustion may build up inside the stove and not exit via the flue ways correctly, in this scenario the ODS will activate and turn off the burner. If this occurs try to light the burner again, this could take several attempts in order to get sufficient heat / draw in the flue so the products of combustion can leave the stove correctly.
- Ensure gas pressures and flow rates are correct.
- Test with all ceramics removed
- Confirm that the flame pattern is even across the surface of the burner by removing all of the ceramics. Only do this once pressures and flow rates are confirmed as being correct.
- Double check all ceramics are re-positioned correctly.
- Ensure that both ends of the TTB connection cable are firmly connected and not damaged. If no damage, look at tightening the thermocouple connection to the splitter (see page 9). You will need an 8mm spanner.

Once all the above checks are completed, leave the appliance in a fully commissioned state.

Servicing Instructions

Servicing should be carried out annually by a qualified installation engineer.

- Remove the coals and clean any dust and debris from the top of the burner unit. Ideally a vacuum cleaner should be used, but a soft brush will do.
- Check the condition of the coals. Any damaged ones will affect the efficient operation of the stove and should be replaced with new ones available from your stove supplier.
- All gas supply joints should be checked to make sure they are completely sealed and that the gas supply and pressure is to specification.
- The pilot jets are correctly set and clear of obstruction.
- The chimney should also be checked to make sure there are no restrictions or blockages.
- Finally re-lay the coals and re-light the stove as described previously.

Commissioning Form

THIS SECTION MUST BE COMPLETED AND SIGNED BY THE INSTALLATION ENGINEER

PLEASE LEAVE WITH THE CUSTOMER AND THE APPLIANCE.

Size of Governor setting: (i.e.) Natural Gas 20mbar.

Length and size of gas supply: _____

Meter pressure Fire only on: _____

All Other appliances on: _____

Burner pressure Fire only on: _____

All Other appliances on: _____

Gas rate - Natural Gas - Time for 1 cubic foot in seconds: _____

Overall length of flue: _____

Is there any spillage: _____ Is the draught excessive: _____

Is there any permanent ventilation in the room: _____

Has the room double glazing: _____

Is the aeration of the pilot correct: _____

Does the flame encircle the FFD: _____

Installation Engineers Name: _____

Address _____

Post Code: _____

Telephone: _____ Fax: _____ Mobile: _____

Gas Safe Registration No: _____

Signed: _____ Date: _____

Guarantee

Your decorative gas fire, when installed in accordance with the installation instructions and operated in accordance with these instructions should provide many years of safe and efficient operation.

We thank you for purchasing our product and trust it will provide excellent service.

This appliance carries a manufacturer's guarantee of One (1) Year.

The guarantee begins at the date of purchase. However should the appliance remain un-installed the guarantee period will commence six (6) months after the original purchase date.

Please note consumable items including the ceramic logs, Mica board and rope seals are not covered by this guarantee. The glass on the appliance is also not covered by any form of guarantee.

We agree to repair free of charge or, at our option, replace the appliance or part thereof, which may prove to be defective within the guarantee period.

The guarantee is void if:

- The appliance is not installed and operated in accordance with our instructions, or
- Repairs or modifications have been carried out by the purchaser or any third party not authorised by us or:
- The appliance has been misused or accidentally damaged, or
- Damage is due to 'fair wear and tear.' or
- The appliance or defective component(s) are not returned to us, prepaid postage.
- The appliance has not been serviced annually by a 'Gas Safe Registered' engineer.

The rights given in this guarantee are limited to the UK mainland and are in addition to any to which you may have a statutory entitlement.

Please retain your purchase receipt. We will need to see this in the event of a claim under warranty.

Broseley Fires LTD
19-34 Bedesway,
Bede Industrial Estate,
Jarrow,
Tyne and Wear,
NE32 3BE.
Tel: (0191) 430 0901
Fax: (0191) 430 9522
<http://www.broseleyfires.com>



Energy Efficiency Rating

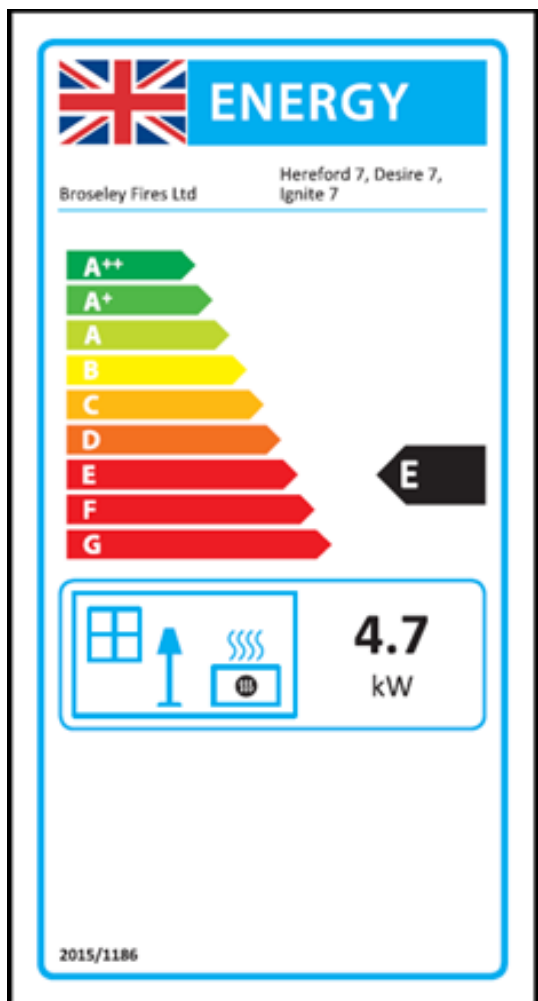

Product Fiche	
Manufacturer :	Broseley Fires LTD
Model No.	Hereford 7, Desire 7, Ignite 7
Fuel Type	Natural Gas I2H
Energy Efficiency Class	E
Indirect Heating Functionality	No
Direct Heat Output kW	4.7W
Indirect Heat Output kW	N/A
EEl	71%
Useful Energy Efficiency (NCV)	High : 80%
Useful Energy Efficiency (NCV)	Low : N / A
Nominal Heat Output	High : 4.7kW
Nominal Heat Output	Low : 2.7kW
Heat Output Temperature Control	Two Manual Stages
Permanent Pilot Power (kW)	N/A
Space Heating Emissions NOx (GCV)	130mg/kWh

Important Note:

The energy efficiency class of this product is defined using a seasonal efficiency calculation which reduces the actual net efficiency of the product where the use of automated heat control, thermostats, window open sensors and timers are not used. This is not to be confused with the net efficiency, or useful efficiency of the appliance (shown in the tables above).

This product MUST be installed by a Gas Safe Registered Installer. Full details are provided in this manual.

Broseley Fires Ltd, 19-34 Bedesway, Bede Industrial Estate, Jarrow, Tyne and Wear, NE32 3BE.