

Download the
Augmented
Reality
Chimney
Builder App
for an instant quote!
See back cover for details



SCHIEDEL INSTALLER
REWARDS

ICID Plus

Installation Instructions

SCHIEDEL

DON'T FORGET TO REGISTER YOUR INSTALLATIONS AND START EARNING
SCHIEDEL INSTALLER REWARDS You can earn up to £8 per installation - available as
Love2Shop vouchers to spend online! See back cover for details

www.schiedel.com/uk

SAP 940002165 - July 2021

Contents

Approvals.....	2	Joining System.....	12
Design Guide.....	3	Standard Chimney Sections.....	12
Mandatory Requirements.....	3	Locking Band.....	12
Prior to Installation.....	4	Gasket Kits.....	13
Ventilation.....	4	Structural Locking Band.....	14-15
Carbon Monoxide Alarms.....	4	Appliance Connector.....	14
Painting.....	4	Adaptors.....	14
Handling.....	4	SW-DW Stove Pipe Starter Section.....	15
Delivery to Site and Storage.....	4	SW-DW Adjustable Starter Section.....	15
Connecting Flue Pipe.....	5	Double Wall Adj. Starter Section.....	16-17
Appliance/Chimney Connection.....	5	Increaser.....	18
Provision for Condensate Disposal.....	5	Anchor Plate.....	18
Connection To Draught Diverter.....	5	Adjustable Pipe/Telescopic Pipes.....	18
Connecting Flue Pipe Diameter.....	5	Inspection Pipe with Test Point.....	18
Distance to Combustibles.....	5	Elbows and 90° Inspection Elbows.....	18
Connecting Flue Pipe.....	6	90° Tee including Drain Cap.....	19
Connecting Flue Pipe Route.....	6	93° Tee including Drain Cap.....	19
Inspection.....	6	135° Tee including Drain Cap.....	19
BS EN 15287-1.....	7-8	Offset Dimensions.....	20-21
Chimney Diameter.....	9	Firestop Components.....	22
Chimney Route.....	9	Support Components.....	24
Connection to Draught Diverter.....	9	Typical Installations.....	32-35
Direct connection.....	9	Protect Box.....	36-37
Distance to Combustibles.....	10	System Design.....	38-39
Enclosure/Shafts.....	10	Typical External Installations.....	40
Support Components.....	11	Load Bearing Data.....	41
Chimney Termination.....	11	Component Weights.....	41
Terminals.....	11	After Installation.....	42
Installation Instructions.....	12	Product Guarantee.....	43

Approvals



ICID Plus is CE Certified to EN1856-1 TÜV 0036 CPR 9195 010 with designations:

ICID Plus is CE Certified to EN1856-2 TÜV 0036 CPR 9195 042 with designations:

System Chimney EN1856-1		
T450 N1 W V2 L50050 G60 T450 N1 D V3 L50050 G60 60mm Distance to combustibles in a combustible shaft*	T450 N1 W V2 L50050 G50 T450 N1 D V3 L50050 G50 50mm Distance to combustibles in a non combustible shaft or in free air*	T200 P1 W V2 L50050 O00 Zero distance to combustibles*
Connecting Flue Pipe EN1856-2		
T450 N1 D V2 L50050 G100 M		

For full information please see p.8 - Distance to Combustibles Section

- Manufactured under a Quality Management Scheme approved to BS EN ISO 9001
- 4 Hour Fire Rating to BS476 Part 20
- Certified for corrosion resistance on gas, oil and solid fuel by Gastec, MPA and TÜV
- HETAS listed for use on solid fuel applications.

Design Guide

MANDATORY REQUIREMENTS

Connection to an appliance which is not connected to the fuel supply, should be carried out by a competent person. We recommend the use of HETAS approved installers for solid fuel applications. If installation is carried out by a non HETAS registered installer, the installation must be certified by a local Building Control inspector. Connection to an appliance that is connected to the fuel supply must be carried out by a Gas Safe (Gas) or OFTEC (Oil) registered installer.

The design guide must be read in conjunction with the detailed component installation instructions. For full design and installation details the key referral documents are:

- BS EN 1856-1: Chimneys - System Chimney Products
- BS EN 1856-2: Connecting Flue Pipes
- BS EN 1859: Metal Chimneys - Testing Methods
- BS EN 1443: Chimneys - General Requirements
- BS EN 15287-1: Chimneys. Design, installation and commissioning of chimneys. Chimneys for non-room sealed heating appliances.
- BS 5440-1: Flueing and ventilation for gas appliances of rated input not exceeding 70kW net (1st, 2nd and 3rd family gases). Specification for installation of gas appliances to chimneys and for maintenance of chimneys.
- Approved Document J: - Combustion appliances and fuel storage systems (England & Wales)
- BS 476 Part 20: Fire tests on building materials and structures.
- DFP Technical Booklet L: - Combustion appliances and fuel storage systems (NI)
- Technical Handbook (Domestic & Non Domestic), Section 3 - Environment (Scotland)
- Appliance Installation Instructions and related standards. Other standards covering specific applications will also be relevant and must be adhered to.

Planning permission may be required, and reference should be made to the local Building Control Department.

Ensure all chimney components are available and check them to ensure there has been no damage. Do not use damaged components. Build the chimney up through the previous designed route which should be as straight as possible.

Please note that an updated version of this brochure is always available online
<https://www.schiedel.com/uk/brochures>

Prior to Installation

VENTILATION

It is very important that sufficient air for combustion and ventilation is provided to the room containing the appliance, to enable correct and efficient working of the appliance and chimney system. Reference should be made to the appliance manufacturer's instructions and recommendations are also given in the Building Regulations Document J, CIBSE guidance notes and BS 5440.

CARBON MONOXIDE ALARMS

The carbon monoxide alarms should comply with BS EN 50291

Where a new or replacement fixed solid fuel appliance is installed in a dwelling, a carbon monoxide alarm must be provided in the room where the appliance is located.

Please follow manufacturers instructions with regards to siting and fixing or alternatively :-

- a) On the ceiling at least 300mm from any wall or if it is located on a wall, as high up as possible (above any doors and windows), but not within 150mm of the ceiling and
- b) between 1m and 3m horizontally from the appliance.

N.B Provision of a carbon monoxide alarm should not be regarded as a substitute for correct installation and regular servicing.

PAINTING

On high temperature applications, where ICID Plus is being connected directly to the stove, then a high temperature paint specification must be used on all appliance connectors and components used within 2 meters of the appliance outlet. See Schiedel ICID Plus catalogue for details of Schiedel High Temperature Paint spec. If painting of any external sections is required, it is important to degrease, dry and prime the exterior surface prior to the application of appropriate heat resistant paint. Schiedel Chimney Systems can provide to special order, chimney sections and accessories painted to an extensive range of British Standard RAL colours – details on application.

HANDLING

It is advised that suitable PPE should be used when handling the products.

DELIVERY TO SITE AND STORAGE

Components should be carefully transported and off loaded. They should be inspected to ensure they have not been damaged, and should be stored off the ground and under cover so that they are protected from accidental damage and the adverse effects of weather.

Connecting Flue Pipe

APPLIANCE/CHIMNEY CONNECTION

Connection to the appliance can be made using Prima Smooth, Prima Plus or alternative approved single wall connecting flue pipes, or ICID Plus. Where painted product is used on a high temperature application, then this must be a high temperature paint specification. See latest Schiedel ICID Plus catalogue for details of Schiedel High Temperature Paint spec.

The connection must be made by using the appropriate appliance connector. When a single wall connecting flue pipe is used to connect an appliance to the chimney, the lower end of the insulated chimney section must extend a minimum of 425mm below the ceiling. When connecting the appliance to the flue pipe all joints between the flue pipe/appliance outlet must be securely caulked and sealed with non asbestos rope (or suitable alternative) and fire cement on solid fuel appliances.

Any flue pipe connection to the chimney **MUST** be made in the same room as the appliance.

PROVISION FOR CONDENSATE DISPOSAL (SUBJECT TO APPLIANCE MANUFACTURERS' RECOMMENDATIONS)

Condensing appliances need provision for drainage. Choose the appropriate flue drainage components normally fitted at the base of the vertical stack and/or close to the appliance outlet. Any 'horizontal' runs must allow for a minimum 3° slope and therefore, where required, 87° bends and 93° tees must be used rather than 90° bends and tees.

CONNECTION TO DRAUGHT DIVERTER

Where the appliance features a draught diverter the connection should rise vertically from it for at least 600mm before any change of direction (unless otherwise specified by the appliance manufacturer). This is in accordance with the recommendations contained in BS 5440 Part 1 section 6.1.4

CONNECTING FLUE PIPE DIAMETER

Connecting Flue Pipe Diameter size should be as recommended by the appliance manufacturer. Under all circumstances the operational requirements of the appliance and the configuration of the flue must satisfy the flue sizing requirements of EN13384-1.

DISTANCE TO COMBUSTIBLES

In accordance with building regulations, it is essential that the correct distance to combustible material is maintained on connecting flue pipes. On solid fuel applications, where there is a risk of soot fire, on unmeasured (NM) designated single wall product, this distance is $3 \times \text{Ø}$ of the pipe, with an absolute minimum of 375mm e.g on both Ø100 and Ø125mm pipe, the distance to combustibles is 375mm and for Ø150 the distance is 450mm to combustibles on both painted and non painted variants. On measured (M) single wall or double wall products this distance will be as declared by the chimney manufacturer. On ICID Plus this distance has been measured and is set at 100mm.

Connecting Flue Pipe

CONNECTING FLUE PIPE ROUTE

Single wall connecting flue pipes should only be used to connect appliances to a Chimney. They should not pass through any roof space, partition, internal wall or floor, except to pass directly into Ceramic, Pumice or brick chimney attached to the building and passing directly into the chimney through the wall. Distance to combustibles must be maintained within the wall space. In order to guarantee this, we recommend the use of our Ignis Protect product.

Within the room where the appliance is situated, connecting flue pipes should be located so as to avoid igniting combustible material.

On solid fuel appliances the maximum length of a connecting flue pipe is 2m. This distance is reduced to 1.5m if any of the acceptable alternative methods of connection are adopted as per BS EN15287-1. (See p.7-8 for full details.)

On appliances with a top outlet, it is recommended that a vertical run of at least 600mm should be allowed immediately above the appliance prior to any change of direction.

On appliances with a rear outlet, it is recommended that there is maximum of 150mm in the horizontal run however under certain conditions, as described in alternative methods in BS EN 15287-1, this may be increased to 450mm. (See p.7-8 for full details.)

Within a system (Connecting Flue Pipe + System Chimney) servicing a solid fuel appliance, there should be no more than 4 changes of direction of maximum 45°. 90° Factory made bends or tees within the system may be treated as being equal to two 45° bends (as per Document J of the Building Regulations issued October 2010).

INSPECTION

On solid fuel applications, to conform to Building Regulations, provisions should be made to enable a chimney to be inspected and cleaned.

An inspection pipe, inspection elbow or a 90° or 135° Tee with tee cap can form a suitable inspection point (unless cleaning/inspection can be done through the appliance). To aid cleaning, sufficient distance should be left between changes of direction to permit the safe passage of cleaning brushes within the system. This is particularly important on solid fuel applications. It is recommended that chimneys serving solid fuel appliances be swept as frequently as necessary, but at least twice a year.

BS EN 15287-1

Acceptable alternative methods of connection

Where a horizontal connecting flue of more than 150mm is required to connect a solid fuel fired appliance to a chimney, an installation method as per the examples below may be used, provided the following criteria is met:-

- The maximum length of horizontal connecting flue pipe does not exceed 450mm;
- A Defra exempt appliance or an appliance, which is limited to burning authorised smokeless fuel only, is installed;
- A calculation according to BS EN13384-1 has indicated safe operation of the proposed configuration, and the results of the calculation are left with the householder along with the appliance installation instructions;
- The appliance manufacturer agrees in writing to the proposed configuration;
- The chimney manufacturer agrees in writing to the proposed configuration;
- The total length of single wall connecting flue pipe is not more than 1.5m;
- The appropriate distances to combustibles from both the appliance and the connecting flue pipe are maintained.

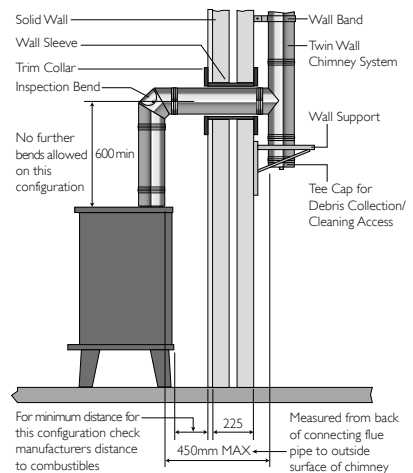
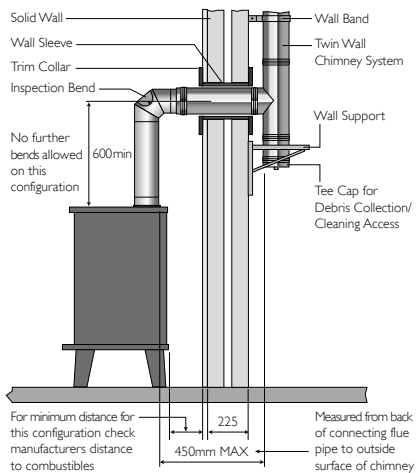

Top Outlet Single Wall Connecting Flue Pipe through Solid Wall into Twin Wall System Chimney

NB Where the connecting flue pipe from the appliance passes through any wall other than the existing chimney wall, the connecting flue pipe must be a System Chimney of twin wall insulated design.

Top Outlet Twin Wall Connecting Flue Pipe through Solid Wall into Twin Wall System Chimney

BS EN 15287-1

Acceptable alternative methods of connection

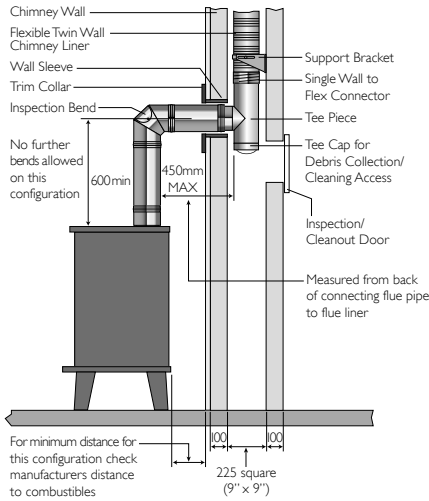

Top Outlet Twin Wall Connecting Flue Pipe into Re-lined Masonry Chimney

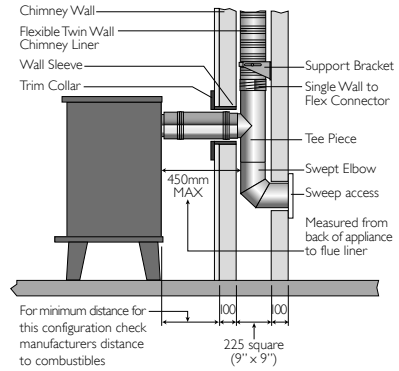

Rear Outlet Twin Wall Connecting Flue Pipe into Re-lined Masonry Chimney

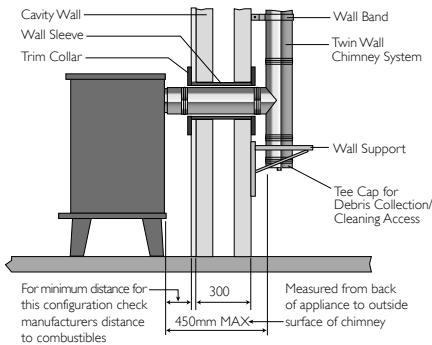

Rear Outlet Twin Wall Connecting Flue Pipe Through Cavity Wall into Twin Wall System Chimney

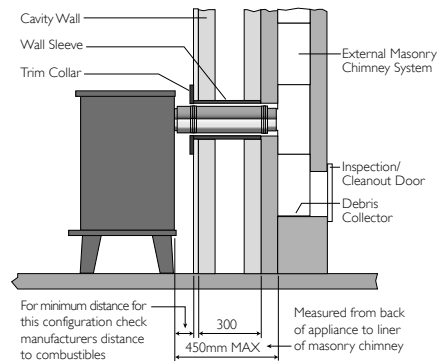

Rear Outlet Twin Wall Connecting Flue Pipe into External Masonry Chimney through a Cavity Wall

System Chimney

CHIMNEY DIAMETER

The chimney size should be as recommended by the appliance manufacturer. Where there is a requirement for a flue diameter smaller than the appliance spigot, then the operational requirements of the appliance and the configuration of the flue must satisfy the flue sizing requirements of EN13384-1 for single appliances, and EN13384-2 for multi appliances.

CHIMNEY ROUTE

The chimney should remain as straight as possible through its vertical run to assist flow. Should it be necessary to offset a chimney run then the following guidelines should be adhered to:

It is recommended that a vertical run of at least 600mm should be allowed immediately above the appliance prior to any change of direction. On natural draught systems on any fuel, it is recommended that there should be no more than 4 changes of direction of maximum 45°. Factory made 90° bends or tees within the system may be treated as being equal to two 45° bends (On fan flued appliances, a calculation should be carried out according to BS EN 13384 to ensure that any installation requiring more than 4 changes of direction will satisfy the flue sizing requirements).

CONNECTION TO DRAUGHT DIVERTER

Where the appliance features a draught diverter the connection should rise vertically from it for at least 600mm before any change of direction (unless otherwise specified by the appliance manufacturer). This is in accordance with the recommendations contained in BS 5440 Part 1 section 6.1.4

DIRECT CONNECTION APPLIANCE TO SYSTEM CHIMNEY

When connecting from the appliance directly to a system chimney, the appropriate appliance connector must be used and the joint between the appliance spigot and the appliance connector must be securely caulked and sealed with non asbestos rope (or suitable alternative) and fire cement on solid fuel appliances.

Where painted product is used on a high temperature application, then this must be a high temperature paint specification. See latest Schiedel ICID Plus catalogue for details of Schiedel High Temperature Paint spec.

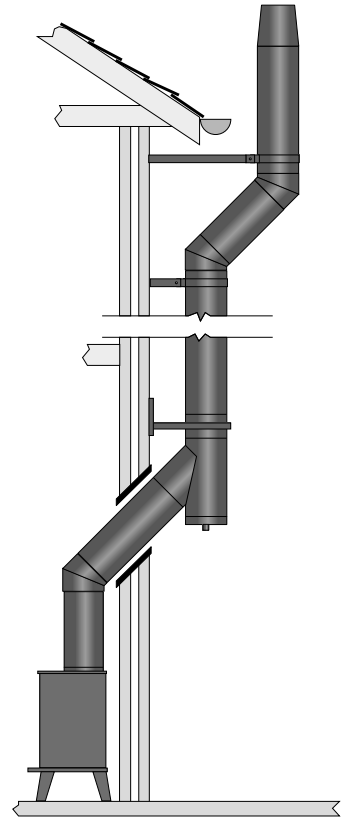

ICID Plus direct connection from appliance.

System Chimney

DISTANCE TO COMBUSTIBLES

In accordance with building regulations, it is essential that the correct distance to combustible material is maintained. On **solid fuel** applications, where there is a risk of soot fire, a distance of **60mm to combustibles** must be maintained within a **combustible floor** and within a **combustible shaft** (see Fig.1 below). There is no need to line the area within the floor cavity with plasterboard; however the **ventilated fire stop plate** and **ventilated support plate** must be used.

On **gas and oil** applications, a distance of **50mm to combustibles** must be maintained within a **combustible floor** and within a **combustible shaft**. The **ventilated fire stop plate** and **ventilated support plate** must be used.

Where the chimney penetrates a **non combustible** floor and where a **non combustible** shaft is used, a distance of **50mm to the shaft** is sufficient. In this case, **non ventilated fire stop plates** and support plates may be used with a **ventilated fire stop** being used where the chimney penetrates into the **roof space**.

On bungalow applications where the chimney runs through either a combustible or non-combustible ceiling, an unventilated bungalow fire stop plate kit can be used. Please note that an unventilated support plate can not be used above the ceiling in this case. The weight of the chimney should be supported using the roof support (see p.29). Distance to combustibles must be respected within the ceiling space (see Fig. 2 below) and mesh frame should be used within the loft space, which must be ventilated (see Fig. 2 below).

Please note that trim collars are not to be used as an alternative to firestop plates. They are designed for use as decorative components only.

ENCLOSURE/SHAFTS

With the exception of the room containing the appliance, a mesh frame or alternative, which meets local Building Regulations, should be used where the chimney passes through any part of the building, where there is a risk of accidental human contact, i.e. a bedroom etc., or where there is a risk of contact with combustible materials stored in a cupboard or in the roof-space, the chimney must be enclosed in an appropriate way to meet Building Regulations. In all cases the minimum distance to any combustible material, including loft insulation, must be respected according to the table on p.2, and any enclosure should be ventilated using the appropriate ventilated fire stops (see p.22-23).

Fig. 1

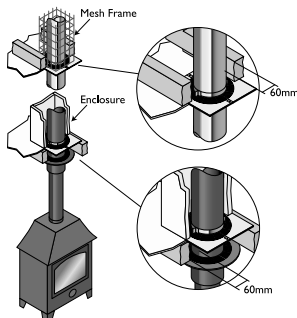

Internal House
Combustible Floors

Fig. 2

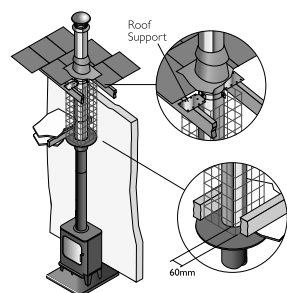

Internal Bungalow (Ventilated Loft Space)
Combustible and Non-Combustible Floors

System Chimney

SUPPORT COMPONENTS

The weight of a chimney system is considerable and requires independent support. Minimal weight should be borne by the appliance. The weight of the chimney can be supported from floor level, or from the wall by using retrofit wall supports or wall support top plates together with side plates or cantilever brackets; or from first floor level by using a support plate and clamp fixed to the floor/ceiling joists.

Wall brackets are non load bearing and provide lateral support only. Refer to the load bearing tables on p.41 for full details of maximum loadings.

Where the flue is free-standing above the roof and its height exceeds 1.5m above the last support or above the roof, a height of up to 3m can be achieved unsupported using the extended locking bands at the joint immediately below the last support and on each pipe joint above the last support.

Alternatively guy wire brackets can be used at the 1.5m level and every 1.5m thereafter in conjunction with guy wires, or telescopic stays (see p.30 or rigid stays provided by others).

CHIMNEY TERMINATION

For full information relating to chimney termination, please refer to Annex M of BS EN 15287-1. As a guide please refer to page p.38-39 of these installation instructions.

TERMINALS

All terminals must be secured with the use of a locking band. On solid fuel appliances, an open termination is normally recommended. However in certain conditions, rain caps or anti-downdraught terminals may be used.

Rain caps and anti-downdraught terminals are available in three versions, with anti-bird mesh, with spark guard, or without mesh. Where a terminal with mesh is used, there is a risk of soot build up, and therefore regular cleaning is required to avoid blockage, particularly when using oil or solid fuel.

Installation Instructions

JOINTING SYSTEM

All joints in the ICID Plus chimney range, which require a locking band, are made by means of a simple twist lock jointing method. This is achieved by pushing together the male and female collars on each end of the main chimney components and twisting the components through 1/6 of a turn to lock the collars into place.

It should be noted that the female collars on elbows and tees are not barbed in order to allow for these items to be positioned according to requirements on site. In all cases the joints should be held securely in place using the locking band, which is supplied with all components with a female collar.

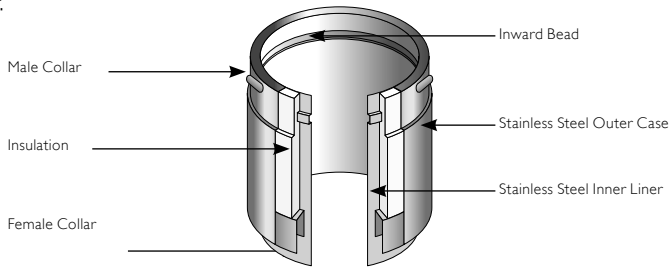

STANDARD CHIMNEY SECTIONS (PIPES, TEES AND ELBOWS)

Before assembling chimney sections, loosen the locking band by lifting the clip. Push the interlocking collars together and twist into position (see Fig.1). Position the locking band so that it grips both collars then fasten using the clip.

Note:-joints must NOT occur within floor or ceiling spaces.

All flue gas carrying components must be installed with the direction arrow on the product label pointing to termination with the external male collar uppermost.

Fig. 1
Without Lip Seal
 ICID Plus for N rated
 Negative Pressure
 Applications
 (i.e. Stoves)

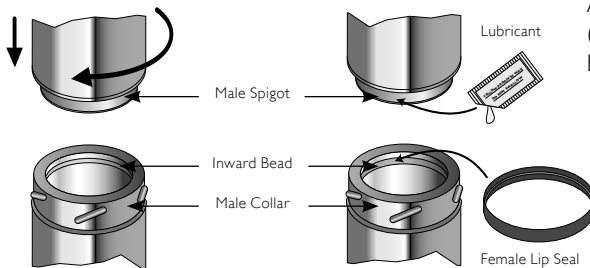

Fig. 2
With Lip Seal
 ICID Plus for P rated
 Positive Pressure
 Applications
 (i.e. Condensing
 Boilers)

LOCKING BAND (SUPPLIED WITH EACH COMPONENT WITH A FEMALE COLLAR)

A locking band must be fitted to every joint in the system. The band is of stainless steel construction and is fitted with a quick release clip.

Installation Instructions

GASKET KITS

The standard single female lip seal kit is used to convert standard components with a male collar for use in condensing applications. The female lip seal must be fitted into the inward bead on the liner just below the male collar. Lubricant should be applied to the outside of the protruding liner of the next component to be fitted (see Fig.2 on page 12)

A separate gasket kit with 2 gaskets (1 female and 1 male) and a sachet of lubricant is required for adjustable pipes.

The female lip seal, with the lip on the inside is fitted, as per a standard component, into the inward bead as shown in Fig.2. The second male lip seal with the lip on the outside of the ring is fitted into the inward bead, which is situated in the top half of the 2-piece adjustable pipe (see Fig.3) and at the bottom of the 1-piece adjustable pipe.

N.B Where a 1-piece adjustable pipe is used, then no female lip seal is required in the groove below the male collar of the preceding pipe.

Fig. 3
2-Piece Adjustable Pipe

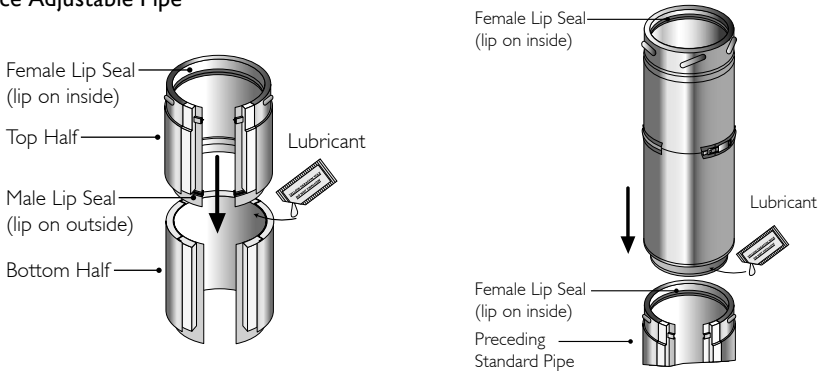

On 2-piece Adjustable Pipe a female lip seal is required on the preceding standard pipe to ensure leakage performance of the system. All lip seals to be added by installer.

1-Piece Adjustable Pipe

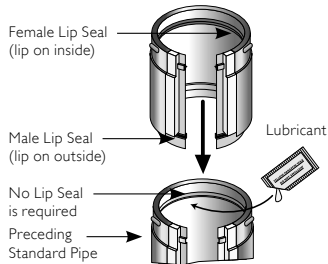

On 1-Piece Adjustable Pipe no lip seal is required on preceding standard pipe, as a male lip seal (once added) will ensure leakage performance. All lip seals to be added by installer.

Installation Instructions

STRUCTURAL LOCKING BAND

The structural locking band, which is purchased separately, is used instead of a standard locking band in a situation where extra structural support is required, for instance where the chimney height is >1.5m above the last support or above the roof. It is also used to provide extra support in long horizontal runs. A maximum of 3m unsupported height can be achieved by fitting the structural locking band on the joint immediately below and on every joint above the last support. Please see diagram on p.40.

STRUCTURAL LOCKING BAND FOR BENDS

The structural locking band for Bend, which is purchased separately, is used instead of a standard locking band in a situation where extra structural support is needed in an offset.

APPLIANCE CONNECTOR

1. The protruding liner of these components should be pushed into the appliance spigot with the male collar pointing upwards. The liner can be trimmed to suit the depth of the appliance spigot.
2. On solid fuel appliances the appliance connector should be sealed to the appliance with fire rope and fire cement or high temperature sealant to provide a gas tight joint. Where painted product is used on a high temperature application, then this must be a high temperature paint specification. See latest Schiedel ICID Plus catalogue for details of Schiedel High Temperature Paint spec.

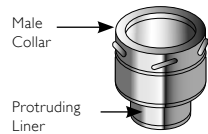

Appliance Connector

ADAPTORS FROM PRIMA PLUS & PRIMA SMOOTH TO ICID PLUS

These components are used to convert from a single wall connecting flue pipe to the ICID Plus system chimney. The protruding liner should be pushed down inside the female socket of the connecting flue pipe, with the male collar pointing upwards.

ADAPTOR TO FLEX/TECNOFLEX PLUS

This component is used to convert from ICID Plus to Flex/TecnoFlex Plus. The screw fit upstand on the ICID section is screwed onto the TecnoFlex liner, then the collar is secured to the preceding ICID Plus section using the locking band provided. On N1 applications, no additional sealant is required on the joint between the adaptor and the TecnoFlex liner. On P1 applications (fan flued) it is recommended that silicone sealant is used at the joint between the adaptor and the TecnoFlexliner.

ADAPTOR FROM ICID PLUS TO PRIMA PLUS

This component is manufactured with an ICID Plus female collar and a Prima Plus female socket, and is used where there is a requirement to convert from ICID Plus to Prima Plus. The ICID Plus female collar should be attached to the previous ICID Plus component and the joint secured using the locking band provided.

Installation Instructions

ADAPTOR FROM ICID PLUS TO PRIMA SMOOTH

This component is manufactured with an ICID Plus female collar and a Prima Smooth female socket, and is used where there is a requirement to convert from ICID Plus to Prima Smooth. The ICID Plus female collar should be attached to the previous ICID Plus component and the joint secured using the locking band provided.

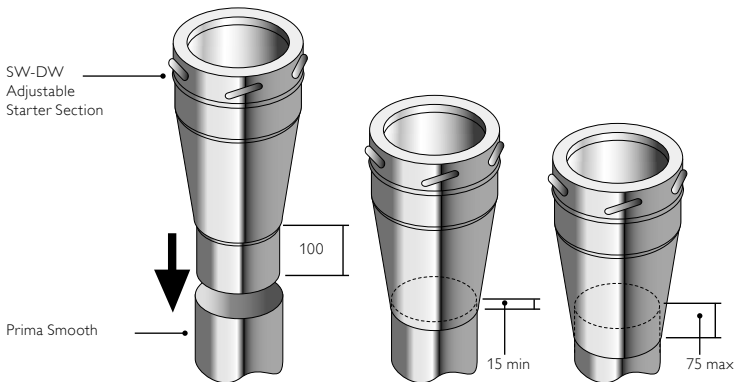

SW-DW ADJUSTABLE STARTER SECTION

The protruding male spigot of the adaptor slides down inside the female socket of the Prima Smooth pipe and the socket of the Prima Smooth pipe slides within the conical section of the starter adaptor, to a maximum length of 75mm into the cone with a minimum of 15mm to ensure a secure connection.

This maximum length of 75mm will leave sufficient space within the adaptor to allow for thermal expansion of the single wall pipe and also to allow for the connecting flue pipe to be removed without cutting, if the appliance has to be moved for servicing.

This component MUST only be fitted to stove pipe and NOT directly to appliance.

Double Wall Adjustable Starter Section

Initial installation

Where painted product is used on a high temperature application, then this must be a high temperature paint specification. See Schiedel latest ICID Plus catalogue for details of Schiedel High Temperature Paint spec.

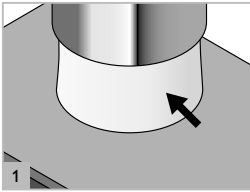

1 Remove loose strip of insulation and keep to one side.

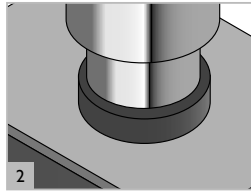

2 Insert male spigot of liner into the appliance spigot.

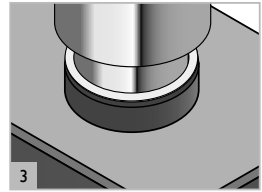

3 Seal using rope gasket, fire cement or similar.

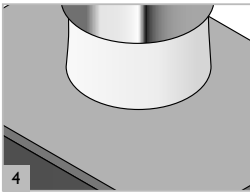

4 Insulate liner using the strip of insulation (see point 1) with joint to rear. Width of insulation can be trimmed to suit.

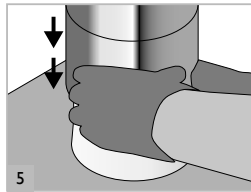

5 Slide adjustable case down over the insulation to cover the appliance spigot.

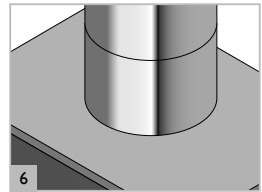

6 Finished installation.

Removal of stove for servicing

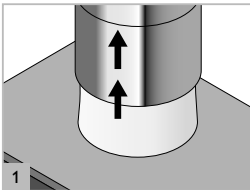

1 Slide adjustable case up inside the outer wall of the chimney.

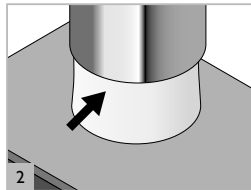

2 Remove two loose insulation strips and keep to one side.

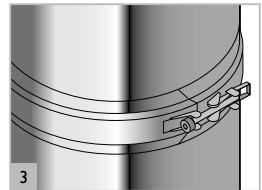

3 Loosen the locking band on the liner using the quick release clip (retain the locking band to one side).

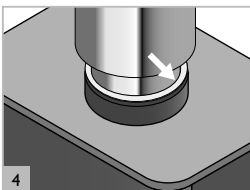

4 Break the fire cement seal between the appliance spigot and chimney liner.

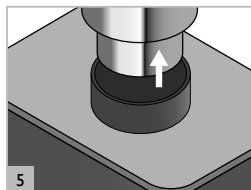

5 Slide the liner spigot up inside the chimney until clear of appliance spigot.

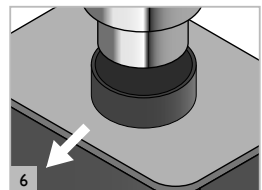

6 Remove the appliance.

Double Wall Adjustable Starter Section

Re-installation of stove after servicing

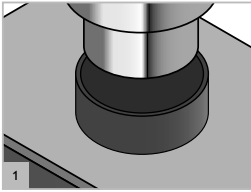

Position stove spigot immediately beneath liner spigot of chimney.

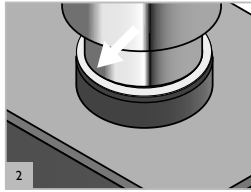

Slide liner spigot down inside the appliance spigot and seal using the fire cement, rope gasket or similar.

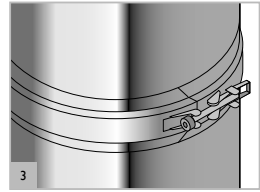

Slide locking band into place around the joint on the liner. Now tighten the bolt on the locking band around the joint of the liner.

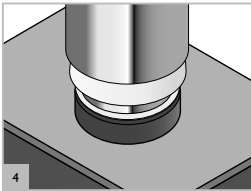

Position narrower strip of insulation around the locking band with joint to the rear.

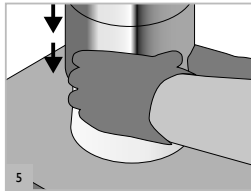

Slide adjustable cover down 5mm past insulation. Position final insulation around spigot with joint to the rear.

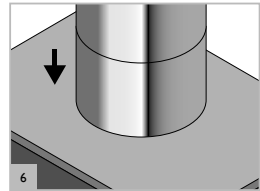

Slide adjustable case down over the insulation to cover the appliance spigot.

Installation Instructions

INCREASER

This component is used to increase from one diameter to the next diameter (e.g.) 125mm to 150mm. The component is fitted in the same way as a standard pipe length and should be secured with the locking band provided.

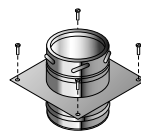

Anchor Plate

ANCHOR PLATE

When commencing an installation with a fire chest, or when extending an existing brick or masonry chimney stack, an anchor plate must be used. The liner of the Anchor Plate should be pushed into the opening of the fire chest with the plate resting on a bed of fire cement. The plate should then be fixed onto the concrete slab by masonry screws fitted through the pre-drilled holes in the plate. In the case of a chimney extension, the liner of the anchor plate fits down inside the existing chimney stack, or if TecnoFlex Plus liner has been used, inside the chimney as a liner; use the anchor plate with screw type connections. Refer Flexible Liners installation instructions for more details. The plate should then be fixed to the top of the existing chimney and sealed using fire cement.

ADJUSTABLE PIPE/TELESCOPIC PIPES

These are used with standard components to achieve an exact length on site and avoid on-site cutting of components.

1. Calculate the length required.
2. Remove insulation as required to achieve the correct length.
3. Fix the adjusted section to standard components using the locking band provided.

Please note that the adjustable pipe is non load bearing. When used in a condensing or a positive pressure application, the relevant gasket kits must be applied by the installer (gaskets purchased separately). Follow p.13 for instructions on Gasket Kits.

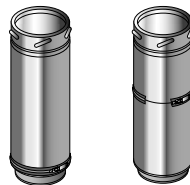

Adjustable Pipe (50-230mm) Telescopic Pipe
a) 215-310mm
b) 350-570mm

INSPECTION PIPE WITH TEST POINT

The inspection length is a component providing the facility for flue inspection and cleaning, including a test point. It is installed as per a standard pipe section. Two versions are available for Dry and Wet systems. The removable inspection door must be parallel with the front of the stove, or at least 3 x the internal diameter from any combustible material.



Inspection Length (Dry Systems)

ELBOWS AND 90° INSPECTION ELBOWS

For offset information on standard elbows, please refer to p.20

Please note that 90° Inspection bends may be incorporated into a connecting flue pipe arrangement on all fuels, please refer to National Annex of BS EN 15387-1 for specific guidance re use on solid fuel applications. In cases of top mounted stoves, a minimum vertical height of 600mm from the appliance is recommended prior to any change of direction in the flue pipe. On condensing appliances 87° bends must be used rather than 90° bends where required in order to ensure correct run off of condensates.

Installation Instructions

90° TEE INCLUDING DRAIN CAP

This component may be used to connect from a connecting flue pipe to the vertical system chimney at 90° or the branch may be used to locate a draft stabiliser. It is installed as per a standard pipe section. Please note that there are no barbs on the female collar in order to allow for the tee to be positioned at the correct angle. It is supplied complete with a drain plug.

Int Ø	100	125	150	180	200
Ext Ø	150	180	200	235	250
A mm	282	301	329	354	394
B mm	150	154	162	176	195
C mm	120	133	142	160	170

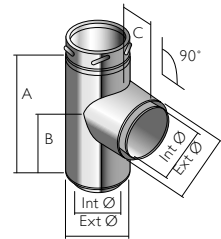

90° Tee

93° TEE INCLUDING DRAIN CAP

This component must be used in place of a 90° tee to connect from a connecting flue pipe to the vertical System Chimney on condensing systems to ensure that condensate can drain down through the system to a drain point. This component is installed as per a standard pipe section.

Int Ø	100	125	150	180	200
Ext Ø	150	180	200	235	256
A mm	285	297	322	356	396
B mm	155	158	166	180	201
C mm	121	136	147	167	177

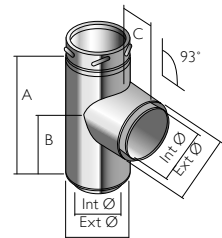

93° Tee

135° TEE INCLUDING DRAIN CAP

There are 2 versions of the 135° tee available. The condensing version has a fully welded liner, so please ensure, prior to installation on a condensing appliance, that you have the fully welded version to hand.

This component may be used in combination with a 45° elbow to connect from a connecting flue pipe to the vertical system chimney. It is installed as per a standard pipe section and provides the least resistance to the flow of the flue gases. Please note that there are no barbs on the female collar in order to allow for the tee to be positioned at the correct angle. It is supplied complete with a drain plug.

Int Ø	100	125	150	180	200
Ext Ø	150	180	200	235	256
A mm	325	336	365	414	444
B mm	254	259	283	326	351
C mm	254	259	283	326	351

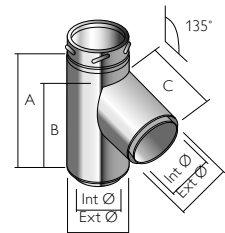

135° Tee

Offset Dimensions

(made by assembling 2 bends)

Offsets for 15° Bend					
Int Ø	100	125	150	180	200
A mm	228	232	234	234	238
B mm	30	31	31	31	31

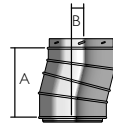

Offsets for 30° Bend					
Int Ø	100	125	150	180	200
A mm	228	230	244	256	271
B mm	61	62	66	69	73

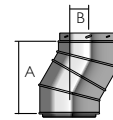

Offsets for 45° Bend					
Int Ø	100	125	150	180	200
A mm	256	254	268	295	309
B mm	106	105	111	122	128

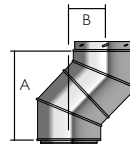

Offsets for 135 Tee° & 45° Bend					
Int Ø	100	125	150	180	200
A mm	383	402	435	497	532
B mm	303	310	334	376	402

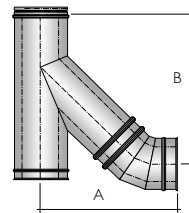

Offset Dimensions

(made by assembling 2 bends)

Offsets for 15° Bend with Standard Pipe Length						
Int Ø		100	125	150	180	200
1460 Eff Pipe	A	1633	1636	1638	1638	1642
	B	406	407	407	407	408
960 Eff Pipe	A	1150	1153	1155	1155	1159
	B	277	277	278	278	278
750 Eff Pipe	A	947	951	953	953	957
	B	223	223	223	223	224
460 Eff Pipe	A	667	671	672	672	676
	B	148	148	148	148	149
293 Eff Pipe		505	509	511	511	515
		104	105	105	105	106
160 Eff Pipe		383	387	388	388	392
		71	72	72	72	73

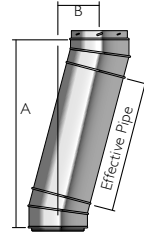

Offsets for 30° Bend with Standard Pipe Length						
Int Ø		100	125	150	180	200
1460 Eff Pipe	A	1487	1489	1504	1515	1530
	B	788	789	793	796	800
960 Eff Pipe	A	1054	1056	1071	1082	1097
	B	538	539	543	546	550
750 Eff Pipe	A	872	874	889	900	915
	B	433	434	438	441	445
460 Eff Pipe	A	621	623	638	649	664
	B	288	289	293	296	300
293 Eff Pipe		476	478	493	504	519
		205	205	209	212	216
160 Eff Pipe		366	368	383	394	409
		141	142	146	149	153

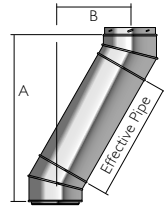

Offsets for 45° Bend with Standard Pipe Length						
Int Ø		100	125	150	180	200
1460 Eff Pipe	A	1284	1282	1296	1323	1337
	B	1134	1133	1139	1150	1156
960 Eff Pipe	A	931	929	943	970	984
	B	781	780	786	797	803
750 Eff Pipe	A	782	780	794	821	835
	B	632	631	637	648	654
460 Eff Pipe	A	577	576	590	616	630
	B	427	427	433	443	449
293 Eff Pipe		459	457	471	498	512
		309	308	314	325	331
160 Eff Pipe		369	367	381	408	422
		219	218	224	235	241

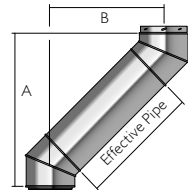

Firestop Components

VENTILATED SUPPORT PLATE (GALVANISED PLATE WITH S/S BAND)

The support plate is used where the chimney passes through a combustible floor, and the weight of the chimney has to be taken at floor level. The support plate must be firmly fixed by using bolts or screws. For load bearing Data refer to tables 1 and 2 on page 41.

1. Frame a four sided level square opening within the joists using timber stringers where necessary to allow for the correct distance to combustibles from the outer wall of the chimney and for 6 fixing points. This distance must be a minimum of 50mm on Gas and Oil applications and 60mm for solid fuel applications (see Fig. 2 below).
2. Lower the chimney section through the opening in the floor, and secure to the next section of pipe.
3. Locate the two halves of the support plates around the chimney section, and secure to the joists using screws or bolts.
4. Remove the self-drilling screws which are fastened to the clamp band. Then fasten clamp band around the chimney section and position on top of the plate. Tighten using the nuts and bolts provided.
5. Using the holes in the clamp band as a guide, fasten the three self-drilling screws to the outer case of the ICID Plus system.

Note: Joints must NOT occur within the floor or ceiling joists.



Ventilated Support Plate

Fig. 1

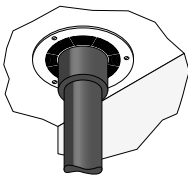

Fig. 2

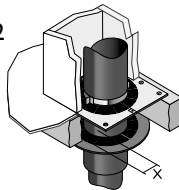
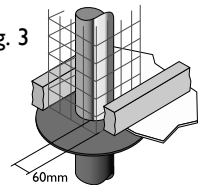
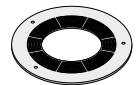

Fig. 3



VENTILATED FIRESTOP PLATE (1 & 2-PIECE ROUND AND 2-PIECE RECTANGULAR)

The ventilated fire stop plates are used in combination with standard ICID Plus pipes where the chimney passes through a combustible floor or ceiling. The outermost circle of ventilation slots gives a distance to combustibles of 60mm. This measures the required distance for solid fuel applications. For gas and oil applications a minimum of 50mm is required, which should be measured on site. The fire stop plate should be positioned around the chimney and fastened through the pre-cut plasterboard onto the timber frame with 4.5mm x 60mm long steel screws (see Fig. 2 above) using the location holes provided, ensuring the required safe distances for the application of either gas and oil, or solid fuel as above.



Ventilated Firestop Plate

Firestop Components

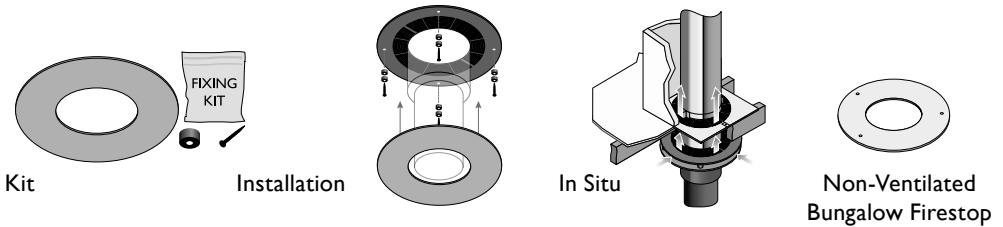

MAGNETIC FIRESTOP COVER (OPTIONAL)

Can be used in combination with 1-piece Ventilated Firestop Plate)

NON-VENTILATED BUNGALOW FIRESTOP

Installed as per a ventilated firestop using the fixing holes provided (see above). Distance to combustibles must be respected - see p.10 for further info.

SUPPORT PLATE WITH S/S CLAMP BAND (NON COMBUSTIBLE FLOOR)

The support plate is used where the chimney passes through a non combustible floor; and the weight of the chimney has to be taken at floor level. The support plate must be firmly fixed to the floor using bolts or screws provided by others. For Load Bearing Data refer to table on page 41.

FIRE STOP PLATE (NON COMBUSTIBLE FLOOR)

This fire stop plate is used exclusively where the chimney passes through a non combustible floor. The two halves of the plate are located around the chimney section and fastened to the floor using bolts or screws provided by others.

Support Components

RETROFIT WALL BAND

1. Slide bracket over and down the chimney to the required position.
2. Once the position of the support has been determined, secure the back bracket to the wall with a method of fixing to ensure adequate attachment and support.
3. The wall bracket provides lateral stability only, it is NOT load bearing and is to be positioned at 3 metre centres.

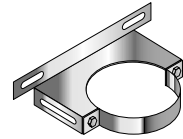

**Retrofit
Wall Band**

WALL BAND (60MM)

Internal and External Application

The wall band is supplied in three parts, two stainless steel split bands which fit tightly around the outside of the chimney and a stainless steel back bracket. The parts are joined together by means of the nuts and bolts provided. The use of the item maintains a fixed distance of 60mm from the outer casing of the chimney to the wall or fixing point.

1. Once the position of the support has been determined, secure the back bracket to the wall with a method of fixing to ensure adequate attachment and support.
2. The stainless steel split band is then positioned around the chimney section and secured with the nuts and bolts provided to the back bracket.
3. The wall bracket provides lateral stability only, it is NOT load bearing and is to be positioned at 3 metre centres.

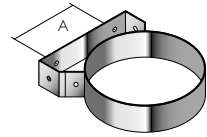

**Wall Band
(60mm)**

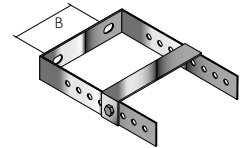

**Adjustable Back
Bracket
(60-300mm)**

ADJUSTABLE BACK BRACKET (60-300MM)

Internal and External Application

The adjustable wall bracket is supplied in three parts, a 'U' shaped stainless steel adjustable section, two bolts for fixing the wall band to the back bracket and a strengthening cross bracket.

1. Once the position of the support has been determined, secure the U shaped bracket to the wall with a method of fixing to ensure adequate attachment and support.
2. Determine the amount of extension required and secure the back bracket of the wall band in place onto the adjustable section (cont.).

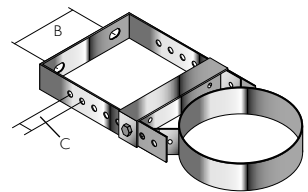

**Wall Band and
Adjustable Back
Bracket Assembly**

Support Components

3. Fasten the strengthening cross bracket in place using the bolts provided.
4. With the back bracket in place, locate the rear portion of the band onto the back bracket, the outer part of the band is then positioned around the chimney section and secure with the nuts and bolts provided.
5. The adjustable wall band provides lateral stability only, it is NOT load bearing and is to be positioned at 3 metre centres.

Int Ø	100	125	150	180	200
Ext Ø	150	180	200	235	256
A mm	131	131	148	185	202
B mm	83	112	132	162	186
C mm	25	25	25	25	25

STRUCTURAL WALL BAND (50MM)

The structural wall band is supplied in two parts, a stainless steel split band which fits tightly around the outside of the chimney and a stainless steel back bracket. The parts are joined together by means of the nuts and bolts provided. The use of the item maintains a fixed distance of 50mm from the outer casing of the chimney to the wall or fixing point. It can be used in combination with the structural wall band extension components to provide for adjustment to various distances from the wall.

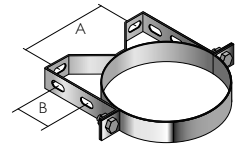

Structural Wall Band

1. Once the position of the support has been determined, secure the back bracket to the wall with a method of fixing to ensure adequate attachment and support.
2. The stainless steel split band is then positioned around the chimney section and secured with the nuts and bolts provided to the back bracket.
3. The wall bracket provides lateral stability only, it is NOT load bearing and is to be positioned at maximum 4 metre centres.

Int Ø	100	125	150	180	200
Ext Ø	150	180	200	235	256
A mm	126	144	164	194	214
B mm	55	55	55	55	55

Support Components

STRUCTURAL WALL BAND EXTENSIONS

Available in 3 different sizes. Type W1 gives adjustment of between 55-100mm from the wall. L1 gives adjustment of between 100-250mm from the wall and L2 gives adjustment of between 100-440mm from the wall.

Once the position of the support has been determined, secure the back bracket to the wall with a method of fixing to ensure adequate attachment and support.

Fasten the structural wall band to the extension brackets using the nuts and bolts provided.

Int Ø	80	100	130	150	180	200	230	250	300
Ext Ø	130	150	180	200	230	250	280	300	350
C	174	194	224	244	274	294	324	344	394
D	180	200	230	250	280	300	330	350	400
E	110	110	110	110	110	110	110	110	110

BASE SUPPORT PLATE WITH DRAIN

This component is used to support the chimney directly from the floor. It should be fastened securely to the floor using bolts or screws provided by others.

LOAD BEARING SUPPORTS

All wall supports and floor supports are designed to provide load bearing support for the chimney. They must be used in combination with the relevant lateral support components, wall bands, guy wire brackets or telescopic roof stays as appropriate. See p.40 for further information.

RETROFIT WALL SUPPORT

- Lower the clamp band over the pipe length with the joint facing the wall.
- On the joint, ensure that the spring washer is between the plain washer and the bolt head,
- Tighten the two fixing bolts on the clamp band using a torque wrench up to a minimum of 10 Nm (Newton-Meters).
- Attach the side brackets to the fixing bolts on the side of the band, but don't tighten.
- Attach the side brackets to the wall using a method of fixing to ensure adequate attachment and support, i.e. shield anchors.
- Mark up the hole positions for the brackets on the wall.
- Fix the brackets to the bolts on the side of the clamp band using the locking nuts provided.
- For maximum height of chimney see load bearing details on p. 41.

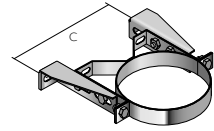

Structural Wall Band with Type W1 Extension Assembly

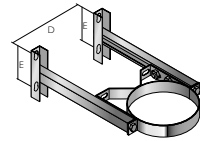

Structural Wall Band with Types L1 & L2 Extension Assembly



Support Components

ADJUSTABLE TOP PLATE

The wall support is designed to be used internally or externally to provide either initial or intermediate support for the vertical chimney. It is used in combination with side plates or with cantilever brackets. The turned down edge at the front of the plates is slotted to allow for the plate to slide along the cantilever brackets and give some positional adjustment. The female socket on the pipe attached to the underside of the plate should be pushed down onto the preceding pipe and the joint secured using the locking band provided. The top plate is then attached to the side plates or the cantilever brackets using the bolts provided through the fixing slots in the top plate (see Fig. 1). The bolts should then be tightened firmly.

For maximum height of chimney see load bearing details, please refer to tables and diagrams on pages 40-41.

Fig.1
Top Plate

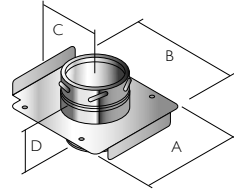

Int Ø	100	125	150	180	200
Ext Ø	150	180	200	235	256
A mm	266	276	296	334	352
B mm	247	287	307	342	363
C mm	127	142	152	170	180
D mm	106	106	106	105	108

SIDE PLATES/CANTILEVER BRACKETS

Once the position of the support has been established in relation to the chimney route, secure the side plates or cantilever brackets to the wall using expansion bolts to ensure adequate attachment and support (see Fig. 2).

Fig.2

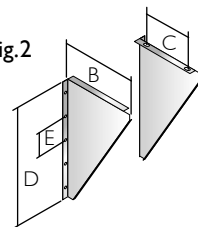

Side Plates

Wall Support Side Plates					
Int Ø	100	125	150	180	200
B mm	235	275	295	325	345
C mm	165	160	180	210	230
D mm	470	470	470	470	470
E mm	100	100	100	100	100

Cantilever Supports			
Type	325	475	570
Ø Range	125-200	125-200	125-200
A mm	325	475	570
B mm	242	242	242

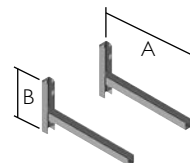

Cantilever Brackets
- Types 325, 475

Support Components

Cantilever Support Adjustment					
Int Ø	100	125	150	180	200
C max					
Type 325	164	134	114	84	64
Type 475	314	284	264	234	214
Type 570	409	379	359	329	309
Type 720	559	529	509	479	459
Type 820	659	629	609	579	559
Type 1004	843	813	793	763	743
Type 1120	959	929	909	879	859
C min					
All Types	50	50	50	50	50

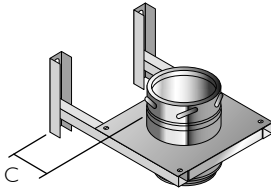

Cantilever Support Adjustment

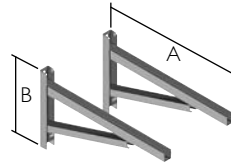

**Cantilever Bracket
- Type 570, 720, 820, 1104, 1120**

CEILING JOIST SUPPORT

The joist support can be used in 2 different ways:

Option 1 - where the chimney passes through a combustible ceiling into the roof space, and the weight of the chimney has to be taken at floor level. The ceiling joist support must be firmly fixed by using bolts or screws. For load bearing Data refer to tables 1 and 2 on page 41. (as per Ventilated Support Plate)

1. Frame a four sided level square opening within the joists using timber stringers where necessary to allow for the correct distance to combustibles from the outer wall of the chimney. This distance must be a minimum of 50mm on Gas and Oil applications and 60mm for solid fuel applications (see Fig. 1 alongside - distance x).
2. Lower the chimney section through the opening in the floor, and secure to the next section of pipe.
3. Locate the two halves of the support plates around the chimney section, and secure to the joists using screws or bolts.

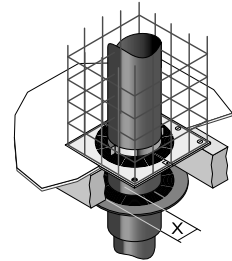
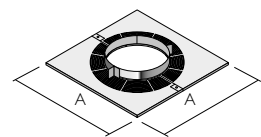

Fig 1



Ceiling Joist Support

Support Components

4. Remove the self-drilling screws which are fastened to the clamp band. Then fasten clamp band around the chimney section and position on top of the plate. Tighten using the nuts and bolts provided.
5. Using the holes in the clamp band as a guide, fasten the three self-drilling screws to the outer case of the ICID Plus system.

Note: Joints must NOT occur within the floor or ceiling joists.

Option 2 - Install as per option 1, but rather than use wooden stringers between the joists, use the ceiling joist support arms, which are fixed to the joists using the screws provided. The plate is then attached to the support arms using the nuts and bolts provided.

ROOF SUPPORT

The roof support is supplied as a kit complete with two side plates for fixing to the roof trusses, a band to give lateral support to the chimney as it passes through the roof, and 3 self tapping screws, which are secured to the chimney through the band to give a load bearing capacity. When the plates are installed above the roof trusses as in Fig.1 the maximum number of pipes, which may be suspended from the roof support is 6 x 1m pipes. When the plates are attached below the trusses as in Fig.2 the maximum number of pipes, which may be suspended is 4 x 1m pipes.

1. The band should be lowered down over the top of the ICID Plus pipe, and positioned so that the side plates are resting on top of the roof trusses as in Fig.1 or below the roof trusses in the case of Fig. 2. The recommended position is always as per Fig.1 where circumstances allow this solution.
2. The band should then be tightened using the nut and bolt provided.
3. Using the holes pre-drilled in the roof support band, drill 3mm holes in the outer case of the chimney section (drill bit should be set for a depth no greater than 10mm to avoid any damage to the liner of the chimney)
4. Use the self tapping screws provided to secure the clamp band to the outer casing of the chimney section.

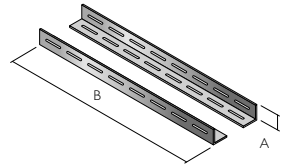

Ceiling Joist Support Arms

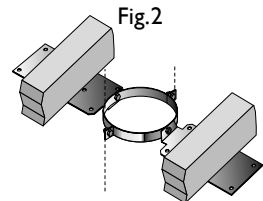
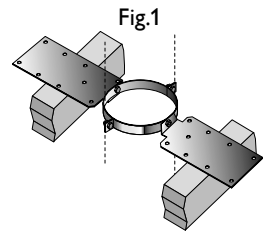

Please note: It is the responsibility of the installer to ensure that the truss to which the roof support is being attached is load bearing and capable of withstanding the weight of the system being installed.

Support Components

GUY WIRE BRACKET

This component should be used to secure unsupported chimney sections above roof level. Guy wires or preferably, telescopic stays or rigid stays (supplied by others) must be fixed to the bracket and secured to suitable anchorage points to ensure that the chimney sections are stable. A maximum chimney height of 1.5 metres from the last support, or from the roof is permitted. Additional height requirements **MUST** be supported using guy wire brackets, with suitable guy wires or rigid stays or by using telescopic roof stays.

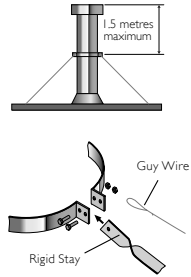

TELESCOPIC ROOF STAYS

The telescopic roof stay kit has been added to the range to allow for extra support on chimneys above roof level, where standard guy wires can not be fitted. The telescopic legs allow for height adjustment from 1.6m-2.5m

Telescopic Roof Stays

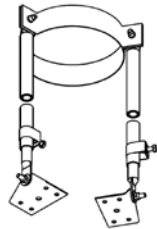

CEILING HANGER

This accessory is designed to support horizontal runs of the chimney from the roof or ceiling and offers adjustment from 130mm to 1115mm.

1. Once the position of the ceiling support has been determined, the section length of uni-rax channel must be securely fixed to the roof or the ceiling using a method of attachment to ensure adequate attachment and support.
2. All items are assembled as shown to attach the length of studding to the channel.
3. Attach the stud connector to the length of studding and connect the eye bolt to the connector.
4. Position the split band around the chimney section and secure to the eye bolt using the nut/bolt provided.
5. Maximum support spacing to be no more than 1.5 metres.

Ceiling Hanger

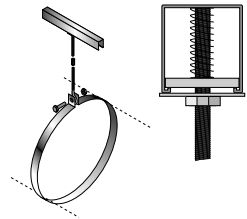

WALL SLEEVE (90° & 135° VARIANTS)

Wall sleeves must be used to protect the building where the chimney passes through a wall (see Fig. 2 & 3). The 90° version is supplied as a straight length whereas the 135° version is mitred at 45 degrees on one end. The sleeve should be cut down to the correct length on site to fit flush with the wall (see Fig. 1 & 2). The sleeve should be adequately weatherproofed, using a good quality building mastic and rope fibre.

Fig. 1

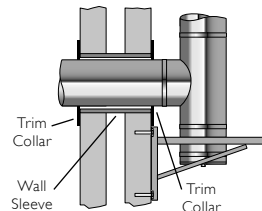

Support Components

TWO PIECE TRIM COLLAR (90° & 135° VARIANTS)

Two piece trim collars are fitted around the ICID Plus pipe where it protrudes through both the inside and the outside of the wall (see Fig. 1 & 2). They should be fastened to the wall using an adequate method of fixing. The trim collars should be adequately weatherproofed back to the wall and around the chimney, using a good quality building mastic or equivalent.

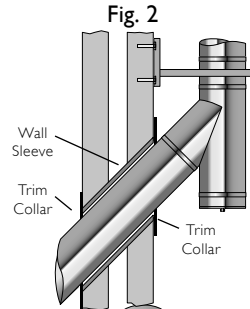

ANGLED FLASHING

Manufactured in sheet aluminium for use on pitched roofs. The base of the flashing should be nailed or screw fixed to the roof batons prior to tiling. The front edge of the flashing should be hooked to the underside of the batons to prevent lifting. This component should be sealed with the mastic sealant provided and **MUST** be used in conjunction with the storm collar supplied.

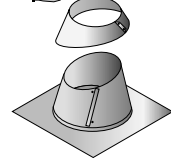

Angled Flashing

FLAT FLASHING

Manufactured in sheet aluminium for use on flat roofs the base of the flashing should be covered by the roofing felt and then sealed. This component should be sealed with the mastic sealant provided and **MUST** be used in conjunction with the storm collar supplied.

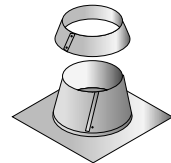

Flat Flashing

STORM COLLAR

The storm collar should be sealed to the outer casing of the flue immediately above the flashing with the mastic sealant provided.



Storm Collar

UNIFLASH

This item, which is manufactured with a malleable base and a silicone cone is used to provide a water tight flashing around the chimney as it passes through a roof pitched between 0-45 degrees. The cone is marked with pipe diameter sizes.

1. Cut the cone to suit the correct diameter of chimney.
2. Slide the flashing down over the top of the pipe and then form the base to the shape of the roof surface.
3. Seal as required.

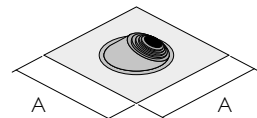

Uniflash

Ext Ø	125-150	180-200
A mm	500	685

Typical Installations

Ignis-Protect

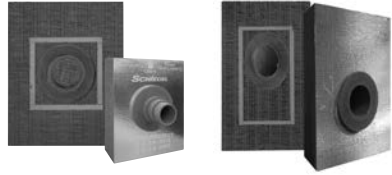

IMPORTANT!

Window and door lintels and their support areas, as well as other bearing elements must not be weakened! In case of uncertainty consult a structural engineer.

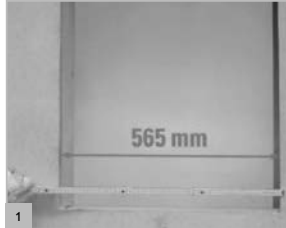

1
Clear installation width required 565mm.



2
Clear installation height of 700mm on 90° version, 1020mm on 45° version for walls between 100 - 200mm thick, and height 1320mm on walls between 250 - 500mm thick.



TIP:

The dimensions of the IGNIS-PROTECT wall bushings have already been matched to the standard centre-to-centre dimensions of wooden stud walls!



3
Remove plasterboard.
NOTE: The vapour barrier must not be damaged!

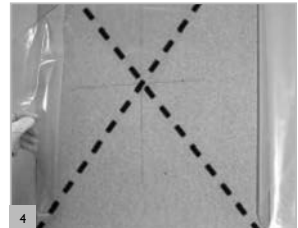

4
Cut a cross shape in the vapour barrier to the required dimensions of the opening (see figs. 1. and 2.)



5
Make the opening. **NOTE: Load Bearing elements must not be weakened! IMPORTANT: follow the safe working notes on p.35.**



6
Remove wood fibre board, thermal insulation etc. from the assembly opening.



7
Install the wooden surround for Ignis-Protect into the studwork.

Typical Installations

Ignis-Protect

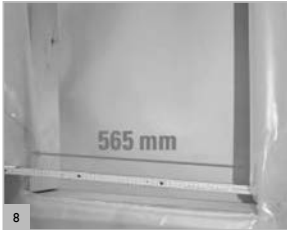

Check width of the opening: 565mm
NOTE: Ignis-Protect must not be shortened on site!



Check height of the opening (see image 2.) **NOTE: Ignis-Protect must not be shortened on site!**



If necessary correct the opening. Replace the thermal insulation right around the assembly opening in the studwork. **IMPORTANT: follow the safe working notes on p.35.**

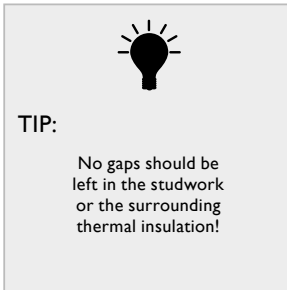

Open up the exterior wall.



Insert Ignis-Protect so that it fits perfectly. The side laminated with foil should be facing inwards!



With Ignis-Protect in place, cut away the vapour barrier flush to the edges.



Secure the junctions with the vapour barrier by applying appropriate sealing tape to the foil lamination.



View of the finished vapour barrier sealed tightly all round.

Typical Installations

Ignis-Protect



Cut a hole in the thermal board to fit the Ignis-Protect outer protection pipe. **IMPORTANT:** follow the safe working notes on page 35.



Replace the prepared thermal board. **NOTE:** The vapour barrier must not be damaged!



TIP:

The Ignis-Protect inner protection pipe and the outer protection pipe are basically designed for 24mm wall planking!



If necessary, shorten the inner and outer protection pipes to be flush with the wall. **IMPORTANT:** follow the safe working notes on page 35.

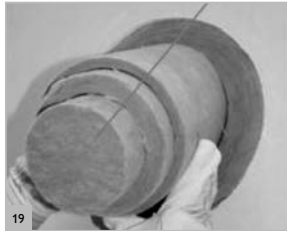

By pulling out the corresponding inner protection pipes and the assembly cap (A) the connection size is adapted to fit the required connecting pipe or transition piece.



TIP:

The inner protection pipes and the assembly cap (A) remain in place until the stove connection pipe is in its final position in the Ignis-Protect.



Check that the thermal insulation is flush with the wall.



IMPORTANT!

Follow the preparation guidelines and relevant drying times of the render system manufacturer!



Application of render over the whole surface. **NOTE:** do not render over the inner protection pipe!

Typical Installations

Ignis-Protect



Example of a design with a double-walled connecting flue pipe.

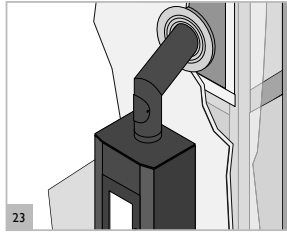

Finished installation.

HEALTH & SAFETY INSTRUCTION

Many building products, including chimney elements are manufactured using natural raw materials which contain proportions of crystalline quartz.

During the mechanical processing of products, such as cutting and drilling, quartz dust is released which can get into the lungs. With higher levels of exposure over longer periods this may result in damage to the lungs (silicosis) and as a consequence of the silicosis disease, to an increased risk of lung cancer.

THE FOLLOWING PROTECTIVE MEASURES ARE TO BE TAKEN

- When cutting and drilling, a P3/FFP3 respiratory protection mask is to be worn.
- In addition, wet-cutting equipment or equipment with dust extraction should be used.

HAZARDS FOR PEOPLE AND THE ENVIRONMENT

Mineral wool insulation materials in this group of products can release fine fibres which may have carcinogenic effects in the lungs. If inhaled, fibres can get into the body and cause damage to health. Larger fibres or fragments of fibres can cause irritation (itching) of the skin, the upper airways and the eyes!

PROTECTION MEASURES AND SAFE PRACTICE

Avoid contact with the skin!

After finishing work, rinse off dust with water and change your clothes. Wash exposed areas of skin thoroughly with soap and if necessary use a skin care product!



Protection measures are required when cutting and drilling. Wet-cutting or dust extraction should be used.



P3/FFP3 Respiratory Protection Mask



Eye Protection



Ear Protection



Eye Protection

When working overhead and where large amounts of dust are produced, wear goggles with side protection.



Hand Protection

Protective gloves, e.g. in leather or nitrile-coated cotton.



Breathing

For low-level activities (exposure category E1/E2) the use of half or quarter masks with P2 filters (white) or FFP2 particle filtering half masks is recommended.

Protect Box

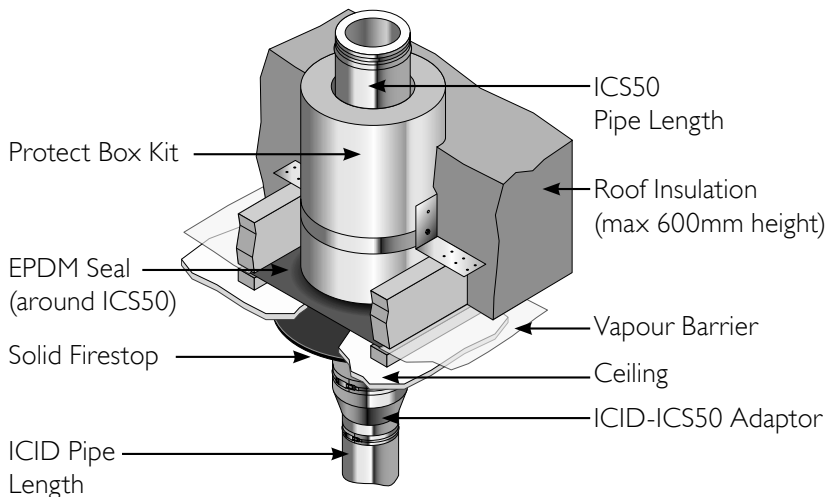

NEW HOUSING AIRTIGHTNESS REQUIREMENTS

Schiedel provide an air tight sealing kit to prevent leakage where the chimney passes through vapour and/or wind barriers. This sealing kit is used in conjunction with our ICS50 System Chimney. The use of 50mm insulation ensures that the outer skin temperature on the chimney remains low enough for the EPDM kit to maintain its elasticity, and remain tight around the ICS50 product, ensuring the air tight joint.

The kit is then fastened securely to the air tight membrane using the special tape supplied in the bag, together with the EPDM seal.

INSTALLATION

Schiedel airtight kits are tailored to meet the outer diameter of Schiedel's twin wall insulated ICS50 System Chimney.

The kit is pulled around the outer case of the ICS50 System Chimney and attached to the air tight membrane, using the special tape provided.

SEALING TAPE

The special tape used with the airtight kit is made from elastic PE film and acrylic adhesive. This combination means the tape is long-lasting and quick to fit (it sticks immediately). To make it as easy to use as possible, the tape comes with a paper liner which is removed prior to use.

N.B. Do not use tape on steel pipe, only to seal the joint between the EPDM seal and the vapour/wind barriers.

APPLICATION

The tape is used to attach the EPDM seal to the vapour and/or wind barriers. Schiedel Chimney Systems Ltd does not advise using the tape on rough surfaces, concrete, brick or bitumen-based materials. Surfaces must be clean, dry and grease-free before fitting.

Protect Box

SECTION THROUGH A ROOF

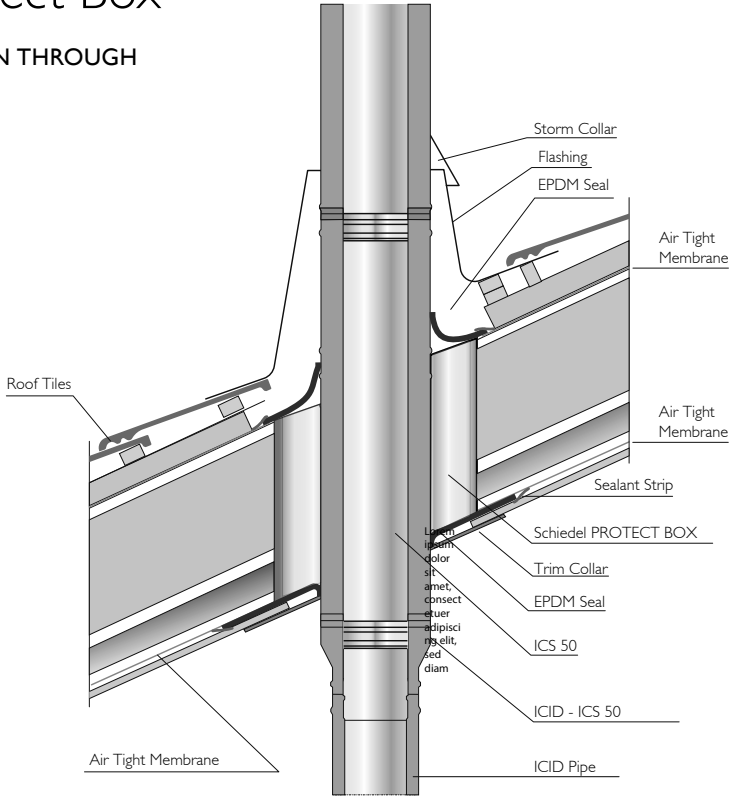

SECTION THROUGH A FLOOR

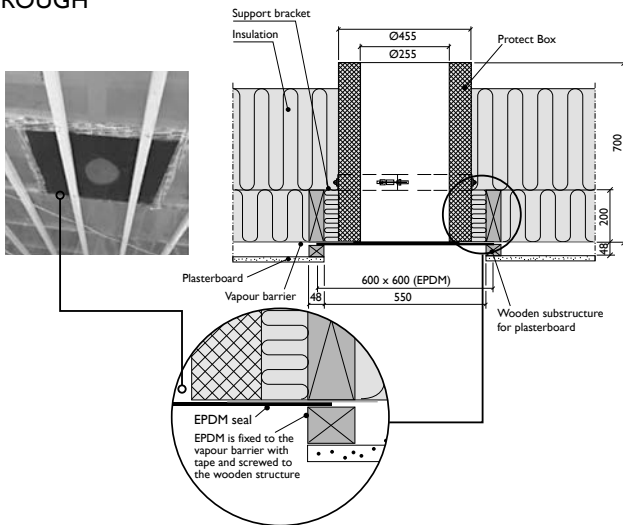

System Design

TERMINALS

Terminals are supplied complete with a locking band. Once the terminal has been pushed into place, the adjustment bolt on the locking band clip should be tightened to ensure that the terminal is properly secured to the previous pipe.

Tapered Terminal



Raincap



Anti Splash Terminal

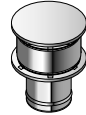

OUTLET SITING

Flue terminations for solid fuel & oil are subject to EN15287-1 2007. Figures A and B illustrate recommendations for the most commonly encountered outlet terminations. Flue terminations for gas in domestic situations are governed by the BS5440-1 2008 Section 4.2. Figure C illustrates recommendations for the most common siting situations encountered. Adjacent taller structures may require increased height. The minimum flue projection through the roof is 600mm to the underside of the terminal.

OUTLET SITING FOR OIL APPLIANCES (<45KW)

Location of outlet		Pressure Jet Burner	Vapourising Burner
M	Above the highest point of an intersection with the roof	600mm	1000mm
N	From a structure to the side of the terminal	750mm	2300mm
O	Above a vertical structure which is less than 750mm (pressure jet burner) or 2300mm (vapourising burner) horizontally from the side of the terminal	600mm	1000mm
P	From a ridge terminal to a vertical structure on the roof	1500mm	Should not be used

OUTLET SITING FOR SOLID FUEL APPLIANCES (<50KW)

Point where flue passes through weather surface (Notes 1, 2)		Clearance to flue outlet
A	At or within 600mm of the ridge	At or within 600mm above the ridge
B	Elsewhere on the roof (whether pitched or flat)	At least 2300mm horizontally from the nearest point on the weather surface and: a) at least 1000mm above the highest point of intersection of the chimney and the weather surface; or b) at least as high as the ridge
C	Below (on a pitched roof) or within 2300mm horizontally to an openable roof-light, dormer window or other opening (Note 3)	At least 1000mm above the top of the opening
D	Within 2300mm of an adjoining or adjacent building, whether or not beyond the boundary (Note 3)	At least 600mm above any part of the adjacent building within 2300mm

System Design

LOCATION OF OUTLET

Fig. A
Outlet siting for Oil
Appliances (<45kW)

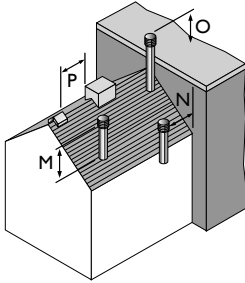
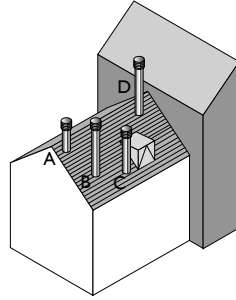
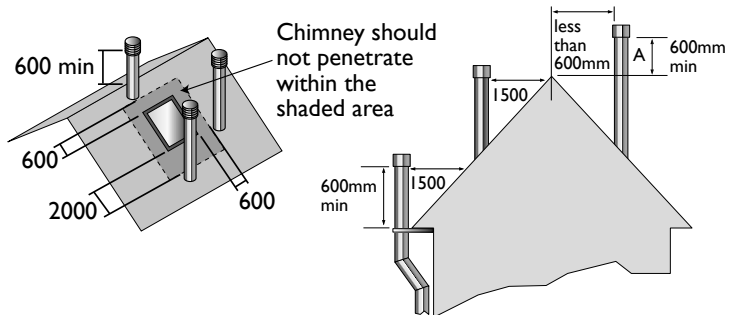

Fig. B
Outlet siting for Solid Fuel
Appliances (<50kW)



1. The weather surface is the building external surface, such as its roof, tiles or external walls.
2. A flat roof has a pitch less than 10°.
3. The clearance for A or B, as appropriate, will also apply.
4. A vertical flue fixed to an outside wall should be treated as equivalent to an inside flue emerging at the nearest edge of the roof.

Fig. C
BS 5440-1 Outlet siting for
Gas Appliances (<70kW)



Typical External Installations

Floor Mounted Installation with Base Drain Section

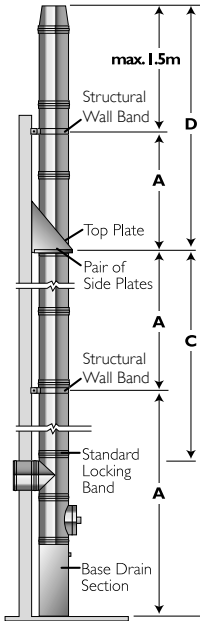

Wall Mounted Installation with pair of Cantilever Brackets and Structural Locking Bands

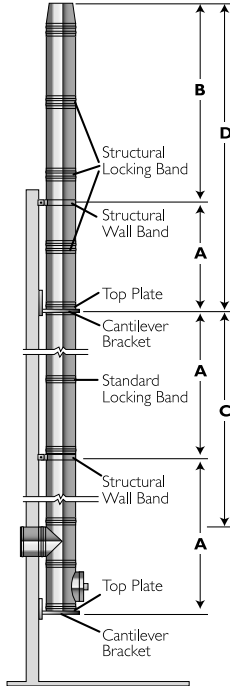

Offset Installation (45°) with pair of Side Plates

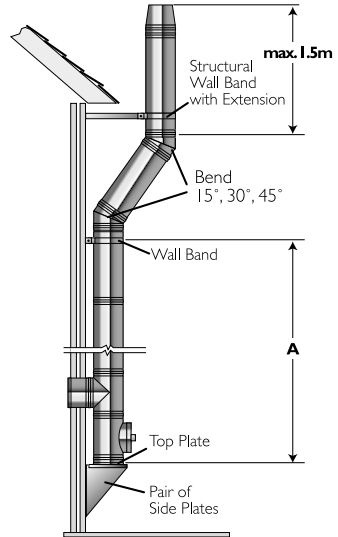

Max Offset Info (in same plane)

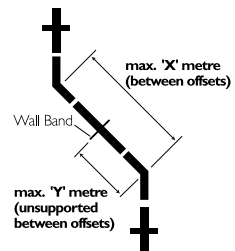

Distance between Lateral Supports					
Int Ø mm	100	125	150	180	200
A (m)	3	3	3	3	3
B (m)	22	22	18	18	18
C (m)	15	15	15	15	15
D (m)	4	4	4	4	4

Int Ø	100-200
X (m)	3
Y (m)	1.5

Load Bearing Data

Maximum Load Bearing (metres of pipe)					
Internal Diameter (mm)	100	125	150	180	200
Base Drain Section	22	22	18	18	18
Retrofit Wall Support	10	10	10	-	-
Top Plate and Locking Band	15	15	15	15	15
Pair or Side Plates (see diagram A)	15	15	15	15	15
Pair or Side Plates (see diagram B)	10	10	10	10	10
Cantilever Support	22	22	18	18	18
Extension Support (Anchor Plate)	1.5	1.5	1.5	1.5	1.5
Ventilated Support Plate (All types)	12	12	12	12	12
Ceiling Joist Support	12	12	12	12	12
Support Plate	12	12	12	12	12
Wall Band 50mm	3	3	3	3	3
Adjustable Wall Band 75-300mm	3	3	3	3	3
Structural Wall Band	4	4	4	4	4
Extension for Structural Wall Band	4	4	4	4	4
Roof Support (above truss)	6	6	6	6	6
Roof Support (below truss)	4	4	4	4	4
Guy Wire Bracket	1.5	1.5	1.5	1.5	1.5
90° Tee + Locking Band	22	22	18	18	18
135° Tee + Locking Band	15	15	10	10	10
Inspection Tee (Rectangular)	22	22	18	18	18

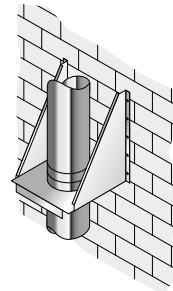

Diagram A

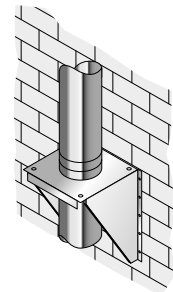

Diagram B

Component Weights

Approximate Weights of Finished Goods (Kg)					
Internal Diameter Length(mm)	1460	960	460	293	160
100	-	5.78	4.18	3.64	3.32
125	11.9	7.1	3.7	2.3	1.5
150	12.9	7.9	4.2	2.6	1.8
180	16.5	9.8	5.1	3.4	2.2
200	17.8	10.6	5.5	3.7	2.3

After Installation

TESTING AND COMMISSIONING PRIOR TO FIRST USE

A flue flow test (Smoke Test) must be performed as outlined in BS EN 15287-1. In addition to this, a draught measurement must also be taken and recorded to verify that the installed system fulfills the draft requirements specified by the appliance manufacturer for the specific appliance.

APPLIANCE OPERATION

Appliance slumbering must be avoided, and if the appliance has been run on low fire conditions for an extended period, then it is advisable to run the appliance at controlled high fire condition for a minimum period of at least 30 minutes afterwards. Prolonged slumbering of the appliance at all times is a contributing factor to a system chimney failure. It is important to maintain sufficiently high flue gas temperatures in order to avoid condensate and acid corrosion problems, and to ensure complete combustion of the fuel at all times. If corrosion occurs due to slumbering, then the guarantee will be invalidated on the system.

MULTI-FUEL APPLICATIONS

Multi-Fuel refers to an appliance which may be used to burn either seasoned wood, or approved solid fuels. These fuels should not be mixed, as this increases the risk of deposits being built up in the liner.

MAINTENANCE

Each chimney must be designed to allow for easy inspection; sweeping should be carried out by competent persons. On solid fuel applications a list of HETAS registered sweeps can be found at www.hetas.co.uk. Chimney flue cleaning and inspection require the use of appropriate tooling – under no circumstances should chemical cleaners or mild steel tools be used to sweep stainless steel chimneys. Cleaning/inspection of any chimney system should be carried out at least once a year, along with maintenance of the appliance, but it is recommended that chimneys serving solid fuel appliances be swept at least twice a year, at the end of the heating season to remove any deposits, which may have built up during the season, and prior to the start of the next heating season to ensure that the flue way is clear of any blockages such as birds nests etc.

We would advise that monthly checks are carried out to ensure that there is no build up of any deposits in the flue way of the connecting flue pipe or system chimney.

PAINTED PRODUCTS

Painted products are relatively maintenance free however should the product require cleaning then please follow the guidelines below:

- Ensure the system has fully cooled down as the paint may have softened due to exposure to high temperatures and this will prevent unintended damage to the paintwork.
- Carefully remove any loose surface deposits with a wet sponge (taking care not to scratch the painted surface).
- Use a soft brush (non abrasive) or a lint free cloth and a diluted solution of a mild detergent, e.g., pH-neutral liquid hand dish-washing detergent in warm water (DO NOT use solvents or aggressive household cleaners) and wipe down.

To remove all remaining residues, finish off with a wipe down using a clean lint free cloth with fresh water.



AR Chimney Builder for Stoves

This App allows the user to see what a stove looks like in a room, as well as calculating the components required.

The App gives you a choice of four basic stove designs, to give an impression of what a typical design would look like in a customer's home.

This amazing App can then be used to assist the installer in selecting the parts required, following a full site survey, which can then be ordered directly from their chosen distributor of the Schiedel product range.



APPLE
iOS
AppStore



GOOGLE
ANDROID
PlayStore

Installer Rewards

Exciting news from Schiedel Chimney Systems for Stove and Chimney Installers! Whenever you register an installation with our easy to use, online guarantee registration portal, you will now accrue points based on the number of installations and installation type.

So head on over to the Schiedel UK website, click **REGISTER AN INSTALLATION** and start to add your installations to take full advantage of our Lifetime Guarantee on Flex and ICID, and also to start earning points!



SCHIEDEL

Schiedel Chimney Systems Ltd.

Crowther Estate

Washington

Tyne & Wear NE38 0AQ

Tel. +44 (0)191 416 1150

sales.uk@schiedel.com | www.schiedel.com/uk

A **standard**
INDUSTRIES COMPANY