

bemodern

FIREPLACES & STOVES | BATHROOM FURNITURE

BROSELEY

evolution

Installation & Operating Instructions

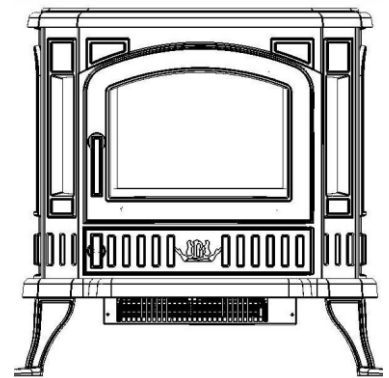
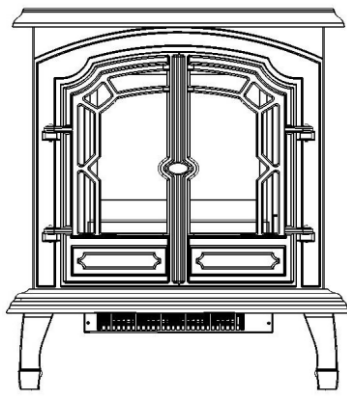
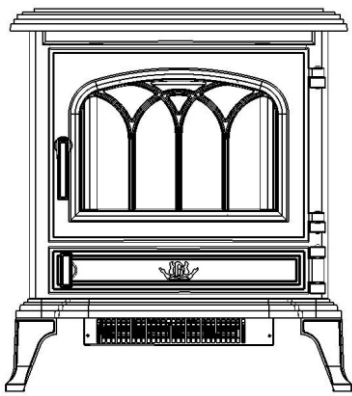

PLEASE NOTE THAT THIS APPLIANCE USES A MOTOR TO OPERATE THE FLAME EFFECT AND THAT IT MAY BE POSSIBLE TO HEAR IT WHERE THE BACKGROUND NOISE IS VERY LOW. THIS IS NORMAL AND SHOULD NOT BE A CAUSE OF CONCERN.

These instructions should be read carefully and retained for future reference

Contents

Please see the relevant pages in the Assembly section for specific information on how to assemble your electric stove:

Models Covered	Page 2
Important Safety Advice	Page 3-5
Technical Specification	Page 6
Assembly – Fitting the Winchester “Wings”	Page 7
Assembly – Installing the Flame Effect Unit	Page 8
Assembly – Positioning the Decorative Fuel Effect	Page 9-11
Operating Your Stove	Page 12-18
Maintenance	Page 19
Guarantee	Page 20

Models Covered

This instruction manual covers the following models:

Canterbury Freestanding Remote
Lincoln Freestanding Remote
Winchester Freestanding Remote

Important Safety Advice

Warning: this appliance must be earthed.

The wires in the main lead to this appliance are coloured in accordance with the following code:

GREEN and YELLOW	Earth
BLUE	Neutral
BROWN	Live

As the colours of the wires in the mains lead of this appliance may not correspond with the coloured markings identifying the terminals in your plug, proceed as follows:

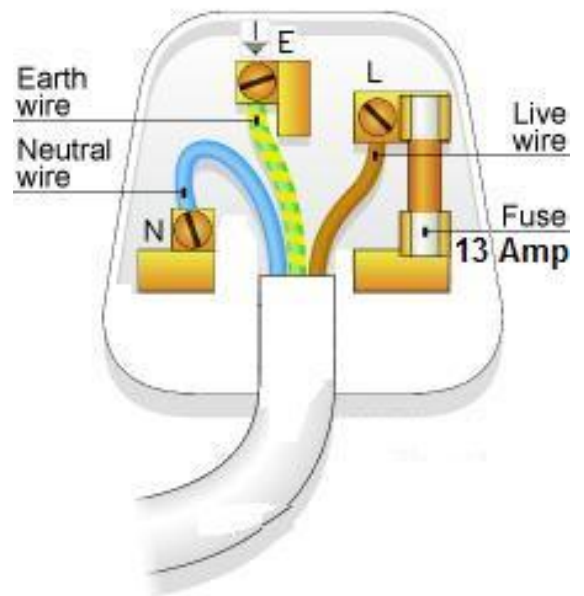

- The wire, which is coloured green and yellow, must be connected to the terminal in the plug with the letter E or by the earth symbol \perp or coloured green or green and yellow.
- The wire, which is coloured blue, must be connected to the terminal, which is marked with the letter N or coloured black.
- The wire, which is coloured brown, must be connected to the terminal, which is marked with the letter L or coloured red.

Important Safety Advice

WARNING:

In order to avoid overheating do not cover the heater.

In order to avoid a hazard due to inadvertent resetting of the thermal cut-out, this appliance must not be supplied through an external switching device, such as a timer, or connected to circuit that is regularly switched on and off by utility.

If the supply cord is damaged, it must be replaced by the manufacturer, its service agent or a similarly qualified person in order to avoid a hazard.

Use the heater in a well-ventilated area. Do not insert or allow objects to enter any ventilation or exhaust opening. To prevent a possible fire, do not block air intakes or exhaust openings in any manner. Do not use on soft surfaces, like a bed, where openings may become blocked.

Do not place this heater near flammable materials, surfaces or substances, as there may be a risk of fire. Keep the above flammable materials, surfaces or substances at least 1m from the front of the product and keep them away from the sides and rear.

If the fire is to be placed in front of an existing chimney opening and there is any risk of chimney debris falling down onto the fire it is recommended that the flue or opening is sealed off with non-combustible non-fibrous insulation materials. Do not place into an existing fireplace that is prone to dampness. Should it be necessary to cap and seal the chimney to prevent personal injury, a professional should be hired to do the work

- **This heater must not be located immediately below a fixed socket outlet or connection box.**
- **DO NOT COVER** this heater, or obstruct the air inlet or outlet otherwise there is a risk of overheating
- During normal operation this appliance will emit noise from the internal fan unit.
- This appliance can be used by children aged from 8 years and above and persons with reduced physical, sensory or mental capabilities or lack of experience and knowledge if they have been given supervision or instruction concerning use of the appliance in a safe way and understand the hazards involved.
- Children shall not play with the appliance.
- Cleaning and user maintenance shall not be made by children without supervision.
- Children and vulnerable people must be supervised at all times when using this appliance, as some parts can become very hot
- Children of less than 3 years should be kept away unless continuously supervised. Children aged from 3 years and less than 8 years shall only switch on / off the appliance provided that it has been placed or installed in its intended normal operating position and they have been given supervision or instruction concerning use of the appliance in a safe way and understand the hazards involved. Children aged from 3 years and less than 8 years shall not plug in, regulate and clean the appliance or perform user maintenance.

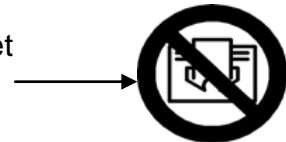

- Some parts of this product can become very hot and cause burns. Particular attention has to be given where children and vulnerable people are present.
- Do not use the heater in the immediate surrounds of a bath, a shower, or a swimming pool.
- The heater must be cooled down completely before any maintenance work is carried out.
- After unpacking, please make sure that the appliance is intact, with no signs of damage caused by transport. If in doubt, do not use the appliance and contact the Service Centre.
- If the supply cord is damaged, it must be replaced by the manufacturer, its service agent or similarly qualified persons in order to avoid a hazard.
- If this fire is supplied through an extension cable, please ensure that it is the only appliance plugged into the extension and that the instructions for the extension cable / reel are followed.
- Do not stand the fire on the carpet – stand on a firm surface, which is free of dust and lint.
- In the event of a fault please disconnect the fire from the mains supply.

TECHNICAL SPECIFICATION

Supply Voltage: AC230V-240V 50Hz

Maximum power consumption: 2KW

Heat output:

Nominal heat output (Pnom): 2KW

Minimum heat output (indicative) (Pmin): 1KW

Maximum continuous heat output (Pmax): 2KW

Auxiliary Electricity Consumption:

At nominal heat output (elmax): 12.5W

At minimum heat output (elmin): 12W

In standby mode (elSB): 0.48W

Type of heat output / room temperature control

Two or more manual stages, no room temperature control	no
With mechanic thermostat room temperature control	no
With electronic room temperature control	yes
Electronic room temperature control plus day timer	yes
Electronic room temperature control plus week timer	yes

Other control options

Room temperature control, with presence detection	no
Room temperature control, with open window	yes
With distance control option	no
With adaptive start control	yes
With working time limitation	no
With black bulb sensor	no

Assembly – Fitting the Winchester “Wings”

For Winchester Electric Models Only

Before inserting the “Flame Effect Unit” into the “Cast Iron Stove Body”, it is necessary to fit the two wings supplied.

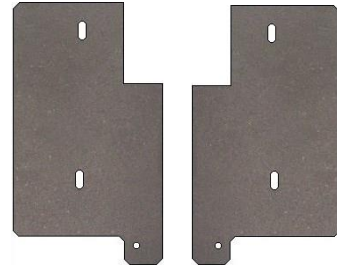

Fig.1 Left & Right Wings

This will allow the flame effect unit to sit at the correct height within the cast iron stove body.



Assembly Sequence:

Step 1 – Remove the flame effect unit from its packaging.

Step 2 – Carefully lay it on its face, on a surface that will not scratch it.

Step 3 – Remove the four screws (Two each side) indicated in the photo above.

Step 4 – Screw the wings into position, using the screws you have just removed.

Look at the photo below to see the finished position of the fitted wings



Assembly – Installing the Flame Effect Unit

Assembly Sequence:

1. Carefully remove all packaging and protective materials from the stove body. Remove and discard the “Transit Bar” from the stove body, this item stops the sides of the stove body from moving in transit. The transit bar has been positioned into the vertical channels where the flame effect unit is to be slotted in place.
2. Remove the cast iron lid from the stove body and lay the stove body on it back.
3. Attach the four legs using the bolts / nuts provided. Stand the main body upright on its feet.
4. Carefully remove all packaging and protective materials from the flame effect unit.
5. Insert the flame effect unit into the stove body, the unit is lowered down carefully from the top of the body with the sides located into the grooves on each side of the stove body. If the flame effect unit will not slide down easily you may need to slacken the bolts connecting the sides to the front and base. **Take care not to trap the cable whilst lowering the flame effect unit into the stove body.**
6. Open the door(s) (Lincoln doors simply pull open, Winchester and Canterbury doors open by removing the handle, turning it anti-clockwise).
7. Position the decorative fuel effect of your choice (coals are simply scattered onto the flat bed, the logs are positioned as shown in the below image).
8. Remove the Perspex from the stove. The Perspex is held in place with four screws on the Canterbury and Winchester but simply slides behind the lugs on the Lincoln.
9. Remove both sides of the protective covering from the Perspex.



10. Finally replace the cast iron lid once the unit is in its final p[osition].

Assembly – Positioning the Decorative Fuel Effect

Log Installation



For the coal effect simply spread the loose coals across the fuel bed in place of the logs, you can even have a mixture of coals and logs for a more unique look.

Operating Your Stove

The appliance can be operated by both remote control and the manual controls on the appliance.

NOTE: To use both remote and manual functions the manual on / off switch must be in “-” position. In order to prevent the product becoming too hot, there is 10s delay when turning on the heater and a 10s delay when turning off the heater.

PREPARATION BEFORE USE

- Check that the supply voltage details on your flame effect fire are in accordance with your electrical supply. Your fire is fitted with a plug incorporating a 13 Amp fuse. In the event of replacing the fuse in the plug supplied, a 13 Amp fuse approved by ASTA to BS 1362 must be used. Before switching on, please read the following fire installation instructions.
- Ensure that the handset batteries are new and inserted correctly.
- In the event of any problems please contact:

Be-Modern Helpline on 0191 430-0901.

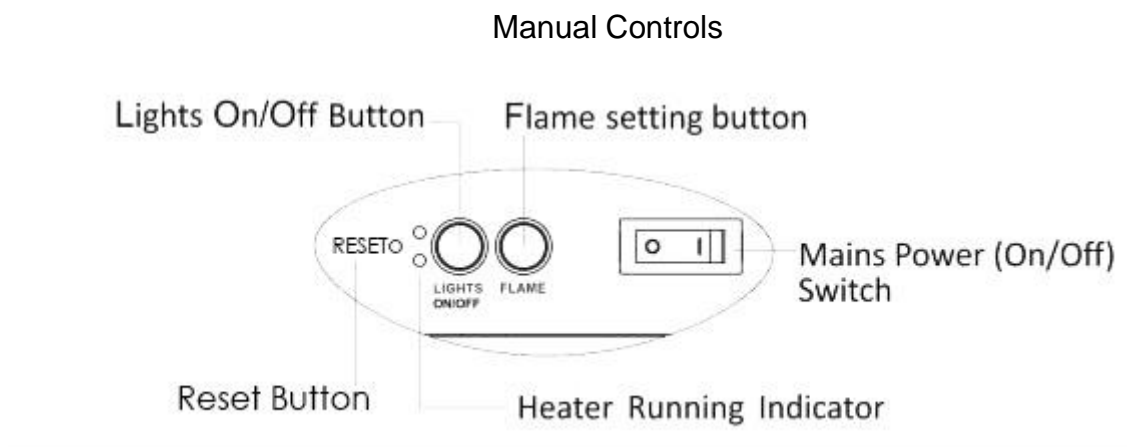

NOTE: The manual button controls basic functions, not a full range of controls. Use the remote hand set to carry out all functions.

Press “FLAME” button to cycle through the 3 kinds of flame effect. Press “LIGHTS ON / OFF” to turn on or turn off the flame.

NOTE: The controls on appliance will lose the memory for all function settings when the switch is set to the OFF position. When the remote runs out of power or when you change the batteries, only the flame function will lose memory and will not affect the timer settings, however, the clock may need adjusting

Remote Controls

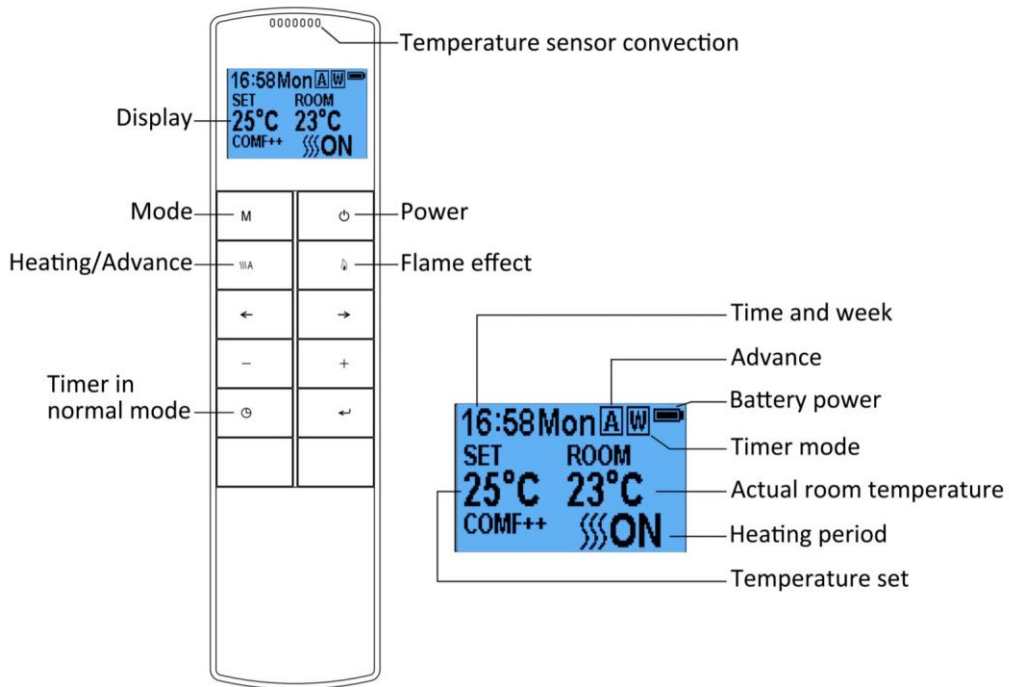

NOTE: This is thermostatic remote control. The remote should be in the same room as fireplace and placed on a flat surface. It must be placed away from the fire so the hot air will not blow on it and affect thermostatic reading.

The communication frequency between the fire and remote has already been set up. If you cannot use the remote with the fire, please follow instructions Step R29 to initiate this connection in point.

Standby for Remote Handset

- R1 The screen shown to the right is when the remote handset is in standby mode.



Before Day / Time set

Turn on / off

- R2 Press  to turn on the flame effect turn off flame effect and heater when in normal mode.

- R3 Press  to turn on/off the flame effect under daily and weekly timer mode.



After Day / Time set

Flame Effect

- R4 Press  to enter the flame effect adjustment screen.

- R5 Press the '←' and '→' button to select the 3 kinds of flame effect.

- R6 Press the '+' and '-' button to select the 5 brightness levels of the flame effect and OFF settings





Normal Mode

- R7 Normal control mode is factory set. If it is not, then press **M** button until the logo **N** shows up at the upper right corner of the screen.

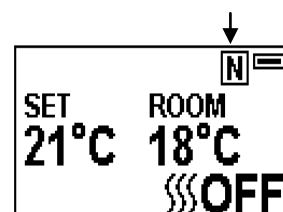
- R8 Press the '+' and '-' button to adjust the temperature setting from 17°C to 25°C by 2 °C intervals



- R9 Press  **A** button to turn on/off heat,  ON  OFF will show at the lower of the screen.

NOTE: It is normal for the fan heater to stop running for periods of time. This happens because the room temperature is at or above the temperature set on the remote control. The heater indicator will be turned off after 10s if you have the flame ON. The heater indicator will stay ON if you use the heating function only.

Count Down Timer

NOTE: This setting is only for normal mode. It allows the appliance to go into standby after a set period of time.

R10 Press  to cycle through the settings from Off and 0.5 hours to 9 hours. The timer logo and time will show on the screen. The heater must be in the ON position.

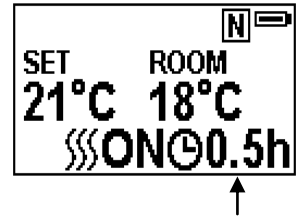

The heater can be automatically run by using daily timer and weekly timer on the remote.

Set up Day, Time and Comfortable temperature.

R11 Press  to turn on the remote handset. Hold the button **M** for 3 seconds to enter the setting screen.

R12 Press the '←' and '→' button to choose Day, Time or your comfortable temperature. The character selected will be highlighted.

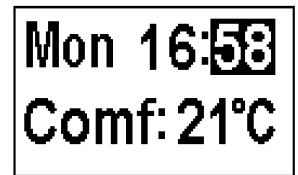

R13 Pressing the '+' and '-' button will adjust the number.

- Time: 24-hour system
- Select your comfortable temperature from 15-25°C.
- Temperature unit: °C, °F

Daily Timer Heating

R14 The following are pre-set heating periods, which can be altered if desired

06:00 until 08:30

17:00 until 22:00

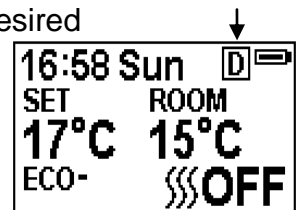

R15 Press **M** until **D** shows at the upper right corner of the screen and enter the daily timer heating mode.

R16 Hold the arrow symbol button  for 6 seconds to enter the daily timer setting. Max 3 timed Heating periods per day.

- Press '←' or '→' to choose hour or minute, press '+' or '-' to set the time.
- Minute will increase / decrease by 15 minutes per press.
- Hold  for 3 seconds or wait for 10 seconds to save and exit the heating time period setting.

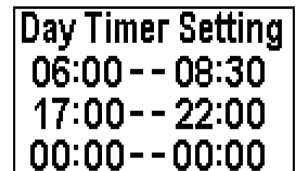

R17 Adjusting the set temperature

- Press the '+' or '-' button to increase or decrease set temperature on the basis of your comfortable temperature setting.
- ECO means 2°C lower than your comfortable temperature setting, ECO- means 4°C lower, COMF+ means 2°C higher, COMF++ means 4°C higher.

R18 To check your daily timer settings press .

R19 If heating needs to be turned off, it will be necessary to go back to the Normal Mode to turn off.

Week Timer Heating

R20 The following are pre-set heating periods, which can be altered if desired.

From Monday to Friday

06:00 until 08:30

17:00 until 22:00

From Saturday to Sunday

06:30 until 09:30

11:00 until 13:00

17:00 until 22:00

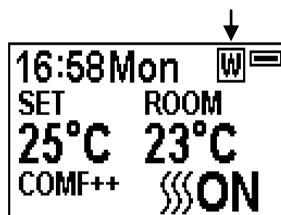

R21 Press **M** until shows at the upper right corner of the screen to enter the week timer heating mode.

R22 Hold button for 6 seconds to enter the week timer setting

- Press '←' or '→' to move the cursor (a flashing underline), press the button in the corresponding week position to select (the character is highlighted) or cancel (the character is displayed normally) the current setting. Several days can be selected together.
- Press the '→' button to move the cursor to the time period setting area. Press or to choose hour or minute, press '+' or '-' to set the number.
- Max 3 heating periods for a day.
- Minute will increase/decrease by 15 minutes per press.
- Press the to set the heating time for the selected day(s) and return to the week line.
- Hold for 3s or wait for 10s to save and exit the heating time period setting.

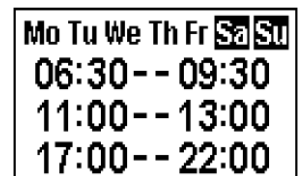
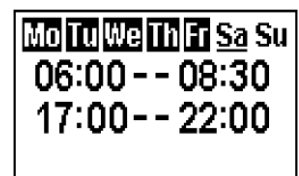

R23 Press , '←' and '→' to check your week Timer settings.

R24 If heating needs to be turned off, it will be necessary to go back to the Normal Control Mode to turn off.

Advance Mode

R25 Under the daily and weekly timer modes, pressing **A**:

- Will turn the heater off when the heater is on during a pre-set heating period.
- Will turn the heater on when the heater is off in between pre-set heating periods.

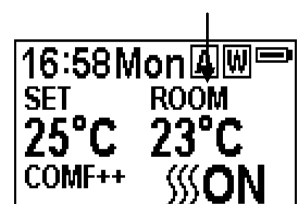

Adaptive Start Control

R26 According to room temperature and set temperature, the heater will automatically come on in time to heat the room to the set temperature at the set time. For example, if your timer is set to start at 18:00 and temperature is set to 23°C, the fire will come on at 17:30 to ensure the room is 23°C at 18:00.

Window Open Detection

R27 When the transmitter detects a rapid drop in room temperature, it will be judged as a window open, the warning icon will be displayed and the heating will be turned off automatically.



R28 After the indoor temperature has risen or a manual override of the warning (by operating remote control) has been done, the fire will return to normal working state.

Set up the communication between the remote and appliance

R29 The below operations should be carried out before programming, when changing to a new remote or in the event the appliance cannot be controlled by the remote:

- Hold the reset button on the appliance for 3 seconds (pen Point may needed) until you hear 3 short beeps from the unit, release the button.
- Press the  button on the remote, the programming is finished when you hear 1 long beep from the appliance.

R30 Resetting the code for remote control is necessary if the appliance operates wrongly or the remote control does not operate correctly.



- Open the back cover of the remote control.
- Press the Reset button on remote handset.
- Follow the steps R29

Remote Control Battery Replacement

When the batteries are at full power, the battery symbol will show 

When the batteries are half full, the battery symbol will show 

When the batteries are out of power and need replacing immediately, the battery symbol will show 

Battery replacement is recommended after 1 year. The batteries are 1.5V alkaline AAA, batteries.

Dispose of old batteries at an appropriate recycling facility.

Safety thermal cut-out

This appliance is fitted with an Electric Safety Control (E.S.). This is a safety device, which switches off the fire if, for any reason, the appliance overheats. The E.S. Control can only be re-set after the appliance has cooled down, in Order to re-set the E.S. Control, proceed as follows:

Switch off the appliance. Unplug at wall socket and leave for approximately 5-10 minutes. Plug in switch on appliance and the E.S. Control will re-set.

Ensure that the appliance is functioning correctly. If the E.S. Control switches off again it is advisable to have the appliance checked by a competent electrician.

Note: -This appliance also has a secondary thermal fuse link incorporated into the heating element that will break the electrical circuit in the event that the heater fan fails to operate. Unlike the E.S. if this link breaks the fire will not be allowed to re set and the appliance should be checked by a competent electrician and the fan/element replaced.

CAUTION: In order to avoid a hazard due to inadvertent resetting of the thermal cut out, this appliance must not be supplied through an external switching device, such as a timer, or connected to a circuit that is regularly switched on and off by the utility.

Maintenance

Warning: Before undertaking any maintenance or cleaning disconnect appliance from main supply. Only competent persons should service / repair appliances.

Cleaning the appliance

The area around the fire should be kept free of any materials such as lint or house dust (i.e. animal hair / carpet fibres) that could be drawn into the internal workings of the appliance and hence affect the performance. We recommend that you clean around the fan grille housing at regular intervals. This can be done using standard vacuum cleaner and suitable attachment.

Perspex

To prevent scratching of the front screen, we recommend only using a slightly damp dish cloth to clean the screen.

Cast Iron Stove Body

A soft brush is normally sufficient to remove everyday dust and general debris from the cast surfaces of the stove. **DO NOT** use any kind of chemical or abrasive cleaning products on your stove as this will damage the paint finish.

Electric Supply Cable

Please note if the supply cord on this appliance is damaged it must be replaced by the manufacturers Authorised Service Agent, or a qualified person to avoid hazard.

Replacing the LED Flame effect:

The LED lighting used in this fire should last for the lifetime of the unit this component should only be replaced by a qualified electrician.

ELECTRIC FIRE GUARANTEE

Be Modern Ltd. (the 'Company') provides a **twelve month** guarantee in respect of electric fire (the 'Product') ranges.

1. The twelve month Guarantee applies to:

- a. All products in the ranges manufactured by the 'Company' (but subject to the exceptions below): where
- b. The product has been purchased and installed within the UK and in respect of
- c. The initial installation: and in favor of
- d. The original purchaser

2. Proof of Purchase must be retained by the Purchaser

3. The twelve month Guarantee does not apply to:

- a. **Damage or inferior workmanship practices whilst the 'Product' is being installed**
- b. **Damage caused by mis-use of the 'Product' or where normal standards of care and use have not been complied with.**
- c. **Damage through a malfunction or an inadequately installed electric fire.**
- d. **Damage or defects due to mis-use, accident or unauthorised alterations.**

4. During the **1 year** after the "Product" has been supplied, the Guarantee covers the making good (whether by repair or replacement at the Company's option) of defects arising from defective manufacture of materials of "Product" covered in Para 1 all at no cost to the purchaser on the proviso:

- a. The Product has been installed as Be Modern recommendations
- b. The Purchaser uninstalls the Product and makes it available for collection by Be Modern.

Note: All lamps supplied with the product are classed as consumable items, and are the Purchasers responsibility to replace.

This Guarantee does not affect your statutory rights

On requiring service the purchaser should contact the retailer who supplied your product who will assist and advise you as necessary.



Waste electrical products should not be disposed of with household waste. Please recycle where facilities exist. Check with your local authority or retailer for recycling advice.



This fire complies with the Safety Standards EN 60335-1 and EN 60335-2-30 which covers the essential requirements of the Low Voltage Directive 2014/35/EU and the EMC standards EN 55014-1; EN 55014-2; EN 61000-3-2 and EN 61000-3-3 which covers the essential requirements of the European Electro Magnetic Compatibility 2014/30/EU and the RED standards EN300220-2, EN301489-1, EN301489-3 and EN6247 which covers the essential requirements of the European Radio Equipment Directive 2014/53/EU.

Control PCB	Remote Control Receiver	Remote Control Transmitter
Hardware: RC01-040A04	Hardware: RF290B V1.2	Frequency: ASK/OOK 433.92MHZ Maximum transmit power: 10mW Hardware: RF290A-TX-V1.3 Software: RF290A_C_V0.6.0.hex

Broseley Fires Ltd.

First Floor Unit B, Knights Court,
Archers Way, Battlefield Enterprise
Park, Shrewsbury SY1 3GA
Tel: (01743) 461444
Fax: (01743) 461446
Email: info@broseleyfires.com

Be Modern Ltd.

19/34 Bedesway, Bede Industrial
Est, Jarrow, Tyne and Wear NE32
3BE
Tel: (0191) 430 0901
Fax: (0191) 430 9522